

1. Features

- Low EMI noise and small footprint (5.75mm²) using inductor-embedded ferrite substrate
- Up to 90% high efficiency using synchronous rectifier technology at 6MHz operation
- PFM/PWM automatic mode switching function for high efficiency operation over full current range
- PWM forced mode for low ripple noise operation
- Wide input voltage range : 2.7~5.5V
- Maximum Load Current: 600mA.
- Fixed output voltage: 1.2V, 1.5V, 1.8V, 3.0V, 3.3V
- Internal soft start, 120 μs start-up time
- Current over load and thermal shutdown protection



2. Description

The LXDC2UR series is a low power step-down DC-DC converter, which is suitable for a space-limited or a noise-sensitive application. The device utilizes an inductor-embedded ferrite substrate, and the substrate eliminates radiated EMI noise and conduction noise efficiently.

By just putting this device, it can be used as a high performance LDO replacement. Its low noise feature and easy to assembly feature assures reliable power supply quality.

The device works in PFM mode at light load and it extends the battery life by reducing quiescent current. At heavy load, its control mode changes to PWM mode automatically and it keeps high efficiency using synchronous rectifying technology. If only heavy load current operation is needed, PWM forced mode is available. In PWM forced mode, ripple noise is reduced. In shutdown mode, the current consumption is up to 1uA.

3. Typical Application Circuit

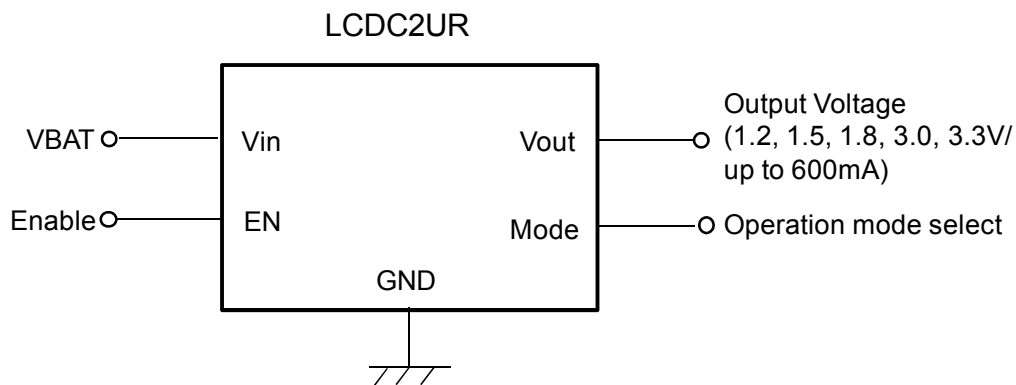

4. Mechanical details

4-1 Outline

TOP VIEW

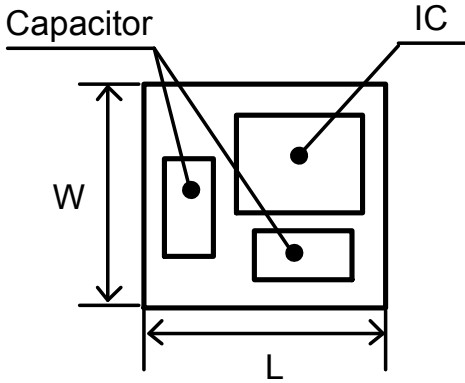

BOTTOM VIEW

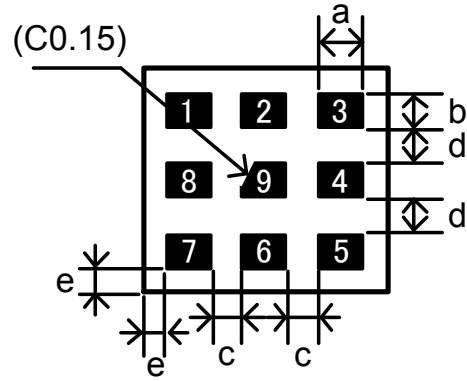

SIDE VIEW

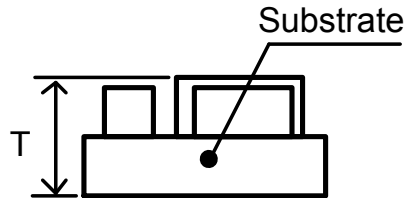

Unit: mm

Mark	Dimension
L	2.5 +/- 0.2
W	2.3 +/- 0.2
T	1.2 MAX
a	0.45 +/- 0.1
b	0.35 +/- 0.1
c	0.325 +/- 0.1
d	0.375 +/- 0.1
e	0.25 +/- 0.2

5. Ordering Information

Part number	Output Voltage	Device Specific Feature	MOQ
LXDC2UR12A-118	1.2V	Standard Type	T/R, 3000pcs/R
LXDC2UR15A-119	1.5V	Standard Type	T/R, 3000pcs/R
LXDC2UR18A-120	1.8V	Standard Type	T/R, 3000pcs/R
LXDC2UR30A-143	3.0V	Standard Type	T/R, 3000pcs/R
LXDC2UR33A-122	3.3V	Standard Type	T/R, 3000pcs/R

6. Electrical Specification**6-1 Absolute maximum ratings**

Parameter	symbol	rating	Unit
Input voltage	V _{in} , EN, Mode	6.3	V
Operating temperature	T _a	-40 to +85	°C
Operating IC temperature	T _{IC}	-40 to +125	°C
Storage temperature	T _{STO}	-40 to +85	°C

6-2 Electrical characteristics (Ta=25°C)

Parameter	Symbol	Condition	Min.	Typ.	Max.	Unit	
Input voltage	V _{in}	V _{out} ≤ 1.8V	2.7	-	5.5	V	
		V _{out} ≥ 3.0V	3.6	-	5.5		
UVLO voltage	UVLO		-	2.05	2.1	V	
Input leak current	I _{in-off}	V _{in} =3.6V, EN=Mode=0V	-	0.1	2	μA	
Operating quiescent current	I _{in-on}	V _{in} =EN=3.6V, Mode=0V	LXDC2UR12A-118	-	37	60	μA
			LXDC2UR15A-119				
			LXDC2UR18A-120				
		V _{in} =EN=5.0V Mode=0V	LXDC2UR30A-143	-	60	80	
LXDC2UR33A-122							
Output voltage accuracy	V _{out}	V _{in} -V _{out} >0.6V	LXDC2UR12A-118	1.176	1.20	1.224	V
			LXDC2UR15A-119	1.47	1.50	1.53	
			LXDC2UR18A-120	1.764	1.80	1.836	
			LXDC2UR30A-143	2.94	3.00	3.06	
			LXDC2UR33A-122	3.234	3.30	3.366	
Load current range	I _{out}		0		600	mA	
Ripple voltage	V _{rpl}	V _{in} =3.6V, I _{out} =300mA, BW=100MHz	LXDC2UR12A-118	-	15		mV
			LXDC2UR15A-119				
			LXDC2UR18A-120				
			LXDC2UR30A-143				
		V _{in} =5.0V, I _{out} =300mA, BW=100MHz	LXDC2UR33A-122				
Efficiency	EFF	V _{in} =3.6V, I _{out} =300mA	LXDC2UR12A-118		82	-	%
			LXDC2UR15A-119		85	-	
			LXDC2UR18A-120		86	-	
			LXDC2UR30A-143		93	-	
		V _{in} =5.0V, I _{out} =300A	LXDC2UR33A-122		91	-	

(*)The above characteristics are tested using the test circuit on section 8.

Parameter	Symbol	Condition	Min.	Typ.	Max.	Unit
EN control voltage	VENH	ON; Enable	1.4	-	Vin	V
	VENL	OFF; Disable	0	-	0.4	
Mode control voltage	VMODH	High; PWM forced mode	1.4	-	Vin	V
	VMODL	Low; Automatic PFM/PWM mode	0	-	0.4	
SW Frequency	Fosc	Iout=300mA, PWM mode	5.0	6.0	7.0	MHz
Discharge resistor	Rds	LXDC2UR12A-118		15		Ω
		LXDC2UR15A-119				
		LXDC2UR18A-120				
		LXDC2UR30A-143				
		LXDC2UR33A-122				
Over current protection	OCP	LXDC2UR12A-118	600	900	1200	mA
		LXDC2UR15A-119				
		LXDC2UR18A-120				
		LXDC2UR30A-143				
		LXDC2UR33A-122				
Start-up time	Ton			120		μs

(*)The above characteristics are tested using the test circuit on section 8.

6-3 Thermal and Current De-rating Information

The following figure shows the power dissipation and temperature rise characteristics example. These data are measured on Murata's evaluation board of this device at no air-flow condition.

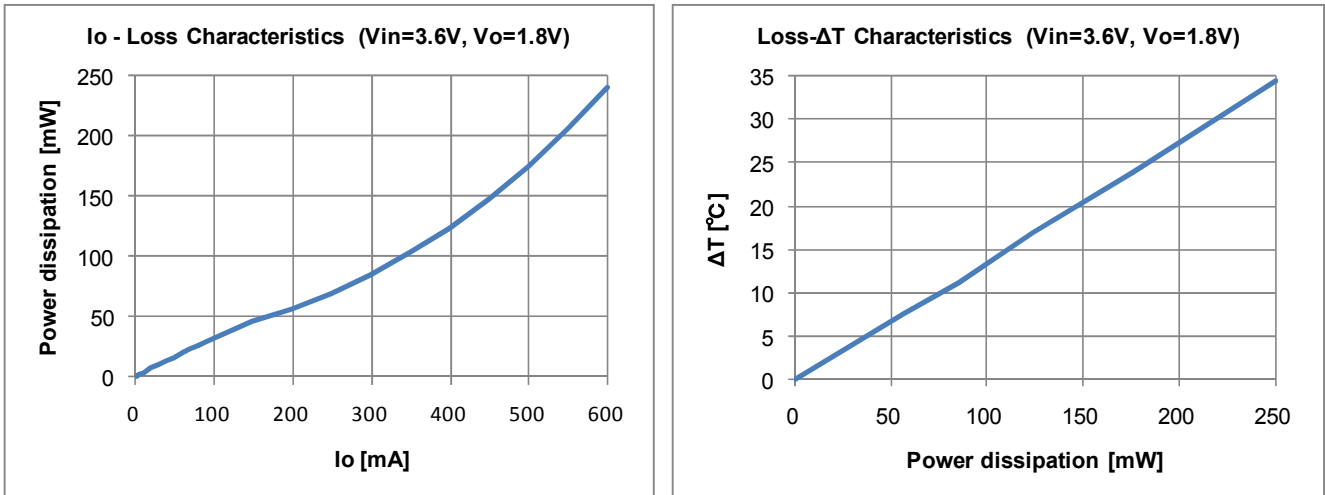

The output current of the device may need to be de-rated if it is operated in a high ambient temperature or in a continuous power delivering application. The amount of current de-rating is highly dependent on the environmental thermal conditions, i.e. PCB design, nearby components or effective air flows. Care should especially be taken in applications where the device temperature exceeds 85°C.

The IC temperature of the device must be kept lower than the maximum rating of 125 °C. It is generally recommended to take an appropriate de-rating to IC temperature for a reliable operation. A general de-rating for the temperature of semiconductor is 80%.

MLCC capacitor's reliability and lifetime are also depending on temperature and applied voltage stress. Higher temperature and/or higher voltage cause shorter lifetime of MLCC, and the degradation can be described by the Arrhenius model. The most critical parameter of the degradation is IR (Insulation Resistance). The below figure shows MLCC's B1 life based on a failure rate reaching 1%. It should be noted that wear-out mechanisms in MLCC capacitor is not reversible but cumulative over time.

- LXDC2UR12A-118, LXDC2UR15A-119, LXDC2UR18A-120

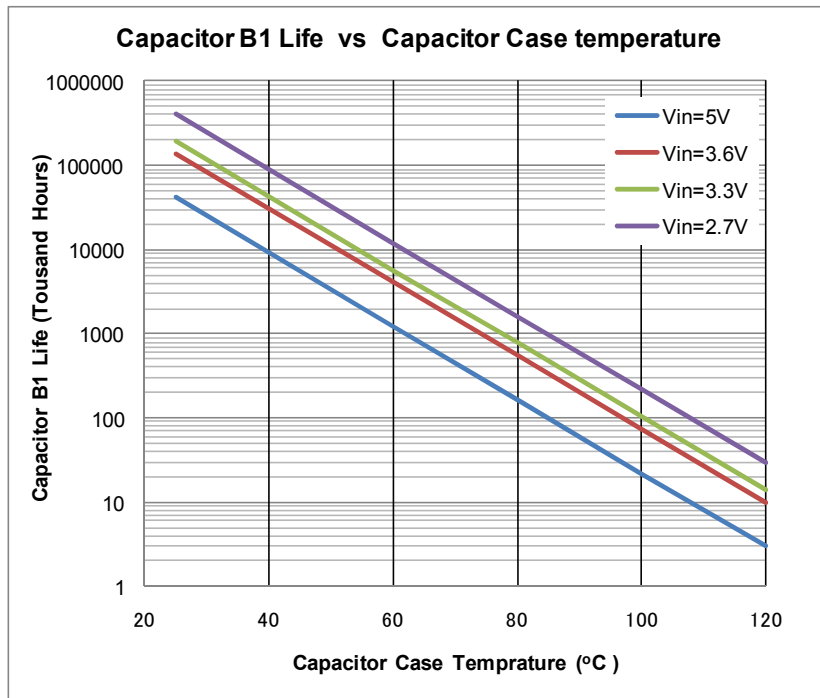

- LXDC2UR30A-143

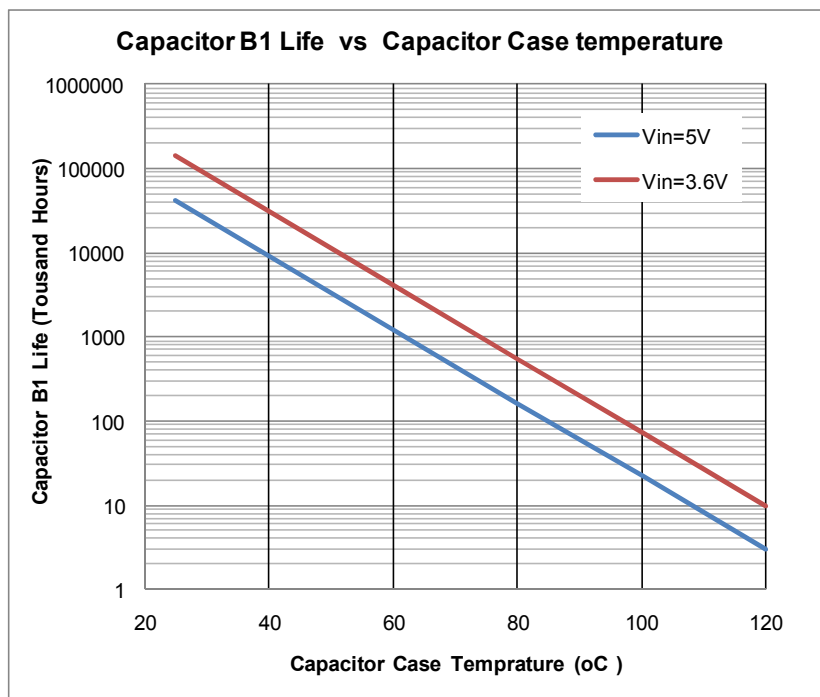

●LXDC2UR33A-122

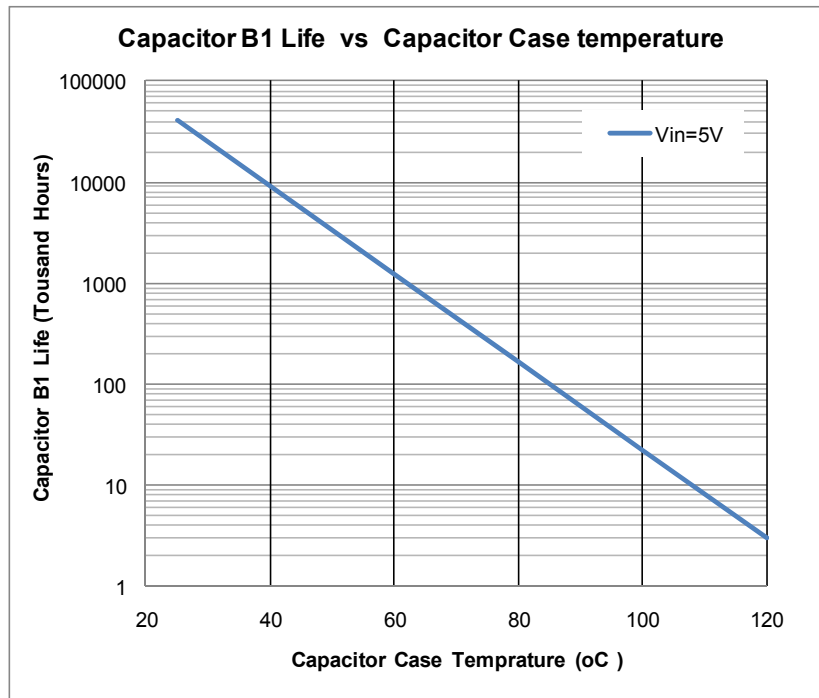

The following steps should be taken before the design fix of user's set for a reliable operation.

1. The ambient temperature of the device should be kept below 85 °C
2. The IC temperature should be measured on the worst condition of each application. The temperature must be kept below 125 °C. An appropriate de-rating of temperature and/or output current should be taken.
3. The MLCC temperature should be measured on the worst condition of each application. Considering the above figure, it should be checked if the expected B1 life of MLCC is acceptable or not.

7. Detailed Description

Mode selection

The MODE pin allows selecting the operating mode. If the MODE pin is pulled to logic low voltage (V_{MODL}), the converter operates automatic PFM and PWM mode. In this mode, the converter operates PFM mode at light load current, and when the load current increase, the operating mode will change to PWM mode automatically. In this mode, the converter can work in high efficiency over wide load current range. The transition current between PFM and PWM is depend on V_{in}, V_{out} and other factors, but the ballpark threshold is about 70-150mA

If the MODE pin is pulled to logic high voltage (V_{MODH}), the device operates in PWM forced mode. In this mode, the converter operates in PWM mode even at light load current. The advantage of this mode is that the converter operates with a fixed frequency that allows simple filtering of switching frequency. In this mode, the efficiency is lower compared to the PFM mode at light load current.

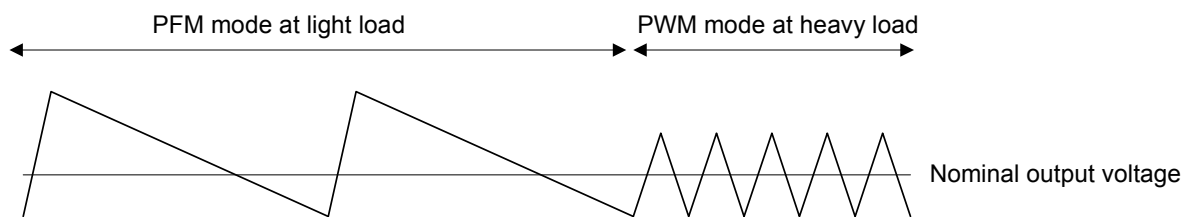

UVLO (Under Voltage Lock Out)

The input voltage (V_{in}) must reach or exceed the UVLO voltage (2.05V_{typ}) before the device begins the start up sequence even when EN pin is kept high. UVLO function keeps away of an unstable operation at low V_{in} range

Soft Start

The device has an internal soft-start function that limits the inrush current during start-up. The soft-start system progressively increases the switching on-time from a minimum pulse-width to that of normal operation. Because of the function, the output voltage increases gradually from zero to nominal voltage at start-up event. The nominal soft-start time is 120 μsec.

Enable

The device starts operation when EN is set high and starts up with soft start. For proper operation, the EN pin must be terminated to logic high and must not left floating.

Pulling the EN pin to logic low forces the device shutdown. The shutdown quiescent current is 0.1 μA (typ).

Discharge Function

LXDC2UR series can actively discharge the internal output capacitor (C_{out}) when it turns off. The discharge time depends on external output capacitance. LXDC2UR series do not need external capacitors, but if you use external output capacitor its discharge time will become longer.

Over Current Protection

LXDC2UR series integrates a current limit function to protect internal components against heavy load or short circuits. When over current event is removed, the device returns to the normal operation automatically.

Thermal Shutdown

As soon as the internal IC's junction temperature exceeds 140°C (typ), the device goes into thermal shutdown. The device returns to its normal operation when the Internal IC's junction temperature again falls below 130°C(typ).

8. Test Circuit

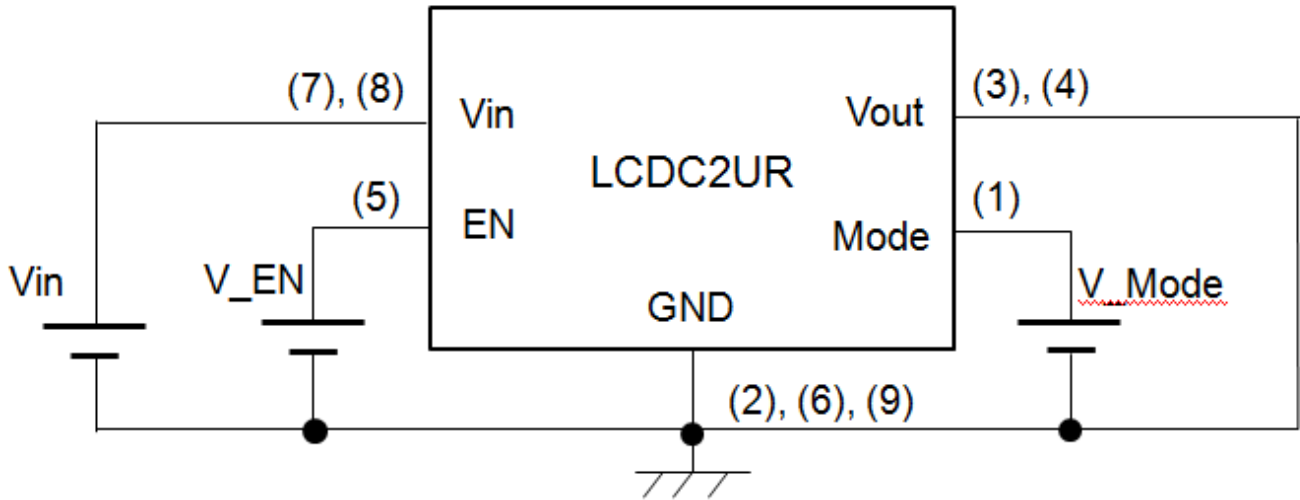

9. Reference Land Pattern

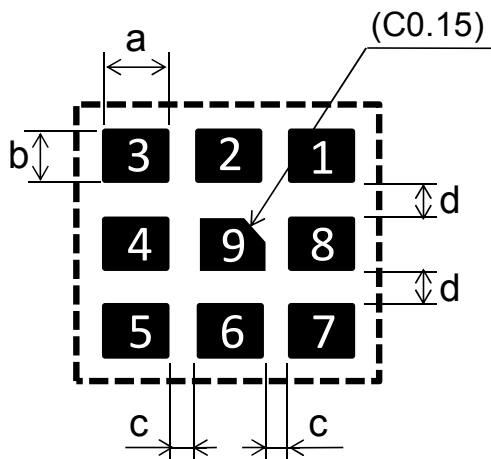

Unit: mm

Mark	Dimension
a	0.45
b	0.35
c	0.325
d	0.375

Notes: this land layout is for reference purpose only.

10. Reliability Tests

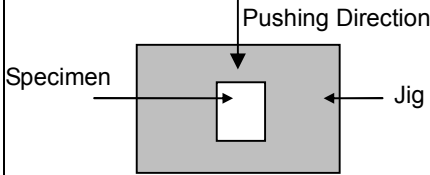
No.	Items	Specifications	Test Methods	QTY	Result (NG)	
1	Vibration Resistance	Appearance : No severe damages	Solder specimens on the testing jig (glass fluorine boards) shown in appended Fig.1 by a Pb free solder. The soldering shall be done either by iron or reflow and be conducted with care so that the soldering is uniform and free of defect such as by heat shock. Frequency : 10~2000 Hz Acceleration : 196 m/s ² Direction : X,Y,Z 3 axis Period : 2 h on each direction Total 6 h.	18	G (0)	
2	Deflection		Solder specimens on the testing jig (glass epoxy boards) shown in appended Fig.2 by a Pb free solder. The soldering shall be done either by iron or reflow and be conducted with care so that the soldering is uniform and free of defect such as by heat shock. Deflection : 1.6mm	18	G (0)	
3	Soldering strength (Push Strength)	9.8 N Minimum	Solder specimens onto test jig shown below. Apply pushing force at 0.5mm/s until electrode pads are peeled off or ceramics are broken. Pushing force is applied to longitudinal direction. 	18	G (0)	
4	Solderability of Termination	75% of the terminations is to be soldered evenly and continuously.	Immerse specimens first an ethanol solution of rosin, then in a Pb free solder solution for 3±0.5 sec. at 245±5 °C. Preheat : 150 °C, 60 sec. Solder Paste : Sn-3.0Ag-0.5Cu Flux : Solution of ethanol and rosin (25 % rosin in weight proportion)	18	G (0)	
5	Resistance to Soldering Heat (Reflow)	Appearance Electrical specifications	No severe damages Satisfy specifications listed in paragraph 6-2.	Preheat Temperature : 150-180 °C Preheat Period : 90+/-30 sec. High Temperature : 220 °C High Temp. Period : 20sec. Peak Temperature : 260+5/-0 °C Specimens are soldered twice with the above condition, and then kept in room condition for 24 h before measurements.	18	G (0)

No.	Items	Specifications	Test Methods	QTY	Result (NG)										
6	High Temp. Exposure	Appearance Electrical specifications	No severe damages Satisfy specifications listed in paragraph 6-2.	Temperature: 85±2 °C Period: 1000+48/-0 h Room Condition: 2~24h	18	G (0)									
7	Temperature Cycle			Condition: 100 cycles in the following table	18	G (0)									
<table border="1"> <thead> <tr> <th>Step</th> <th>Temp(°C)</th> <th>Time(min)</th> </tr> </thead> <tbody> <tr> <td>1</td> <td>Min. Operating Temp.+0/-3</td> <td>30±3</td> </tr> <tr> <td>2</td> <td>Max. Operating Temp.+3/-0</td> <td>30±3</td> </tr> </tbody> </table>				Step			Temp(°C)	Time(min)	1	Min. Operating Temp.+0/-3	30±3	2	Max. Operating Temp.+3/-0	30±3	
Step	Temp(°C)			Time(min)											
1	Min. Operating Temp.+0/-3			30±3											
2	Max. Operating Temp.+3/-0			30±3											
8	Humidity (Steady State)	Temperature: 85±2 °C Humidity: 80~90%RH Period: 1000+48/-0 h Room Condition: 2~24h	18	G (0)											
9	Low Temp. Exposure	Temperature: -40±2 °C Period: 1000+48/-0 h Room Condition: 2~24h	18	G (0)											
10	ESD(Machine Model)	C: 200pF, R: 0Ω TEST Voltage : +/-100V Number of electric discharges: 1	5	G (0)											
11	ESD(Human Body Model)	C: 100pF, R: 1500Ω TEST Voltage : +/-1000V Number of electric discharges: 1	5	G (0)											

11. Measurement Data

Micro DC-DC Converter evaluation board (P2LX0006A)

Measurement setup

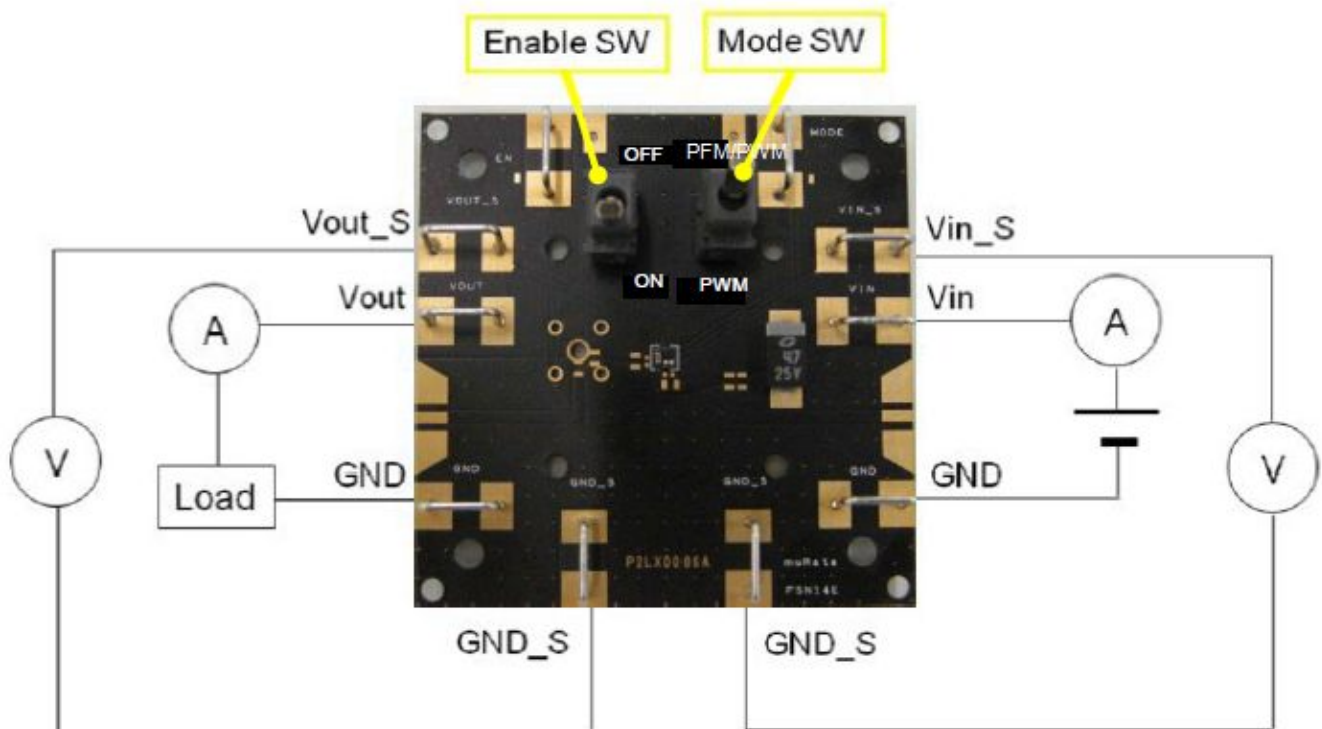

The enable switch has three states (ON, OFF and Open).

1. When it is toggled to “ON” side, the device starts operation.
2. When it is toggled to “OFF” side, the device stop operation and keep shut down status.
3. When it is set to open, the EN pin floats and an external voltage can be applied to the EN terminal pin on the EVB. If you don't apply an external voltage to EN pin, the enable switch should not to be set to the middle position.

The mode switch has three states (PWM, PFM/PWM and Open).

1. When it is toggled to “PWM” side, the device operates PWM forced mode.
2. When it is toggled to “PFM/PWM” side, the device operates PFM/PWM automatic mode.
(LXDC2UR25G-308 and LXDC2UR25G-312 forced PFM mode)
3. When it is set to open, the mode pin floats and an external voltage can be applied to the Mode terminal pin on the EVB. If you don't apply an external voltage to Mode pin, the mode switch should not to be set to the middle position.

Typical Measurement Data (reference purpose only) (Ta=25°C)

Efficiency

• Vin=3.6V, Vout=1.2V

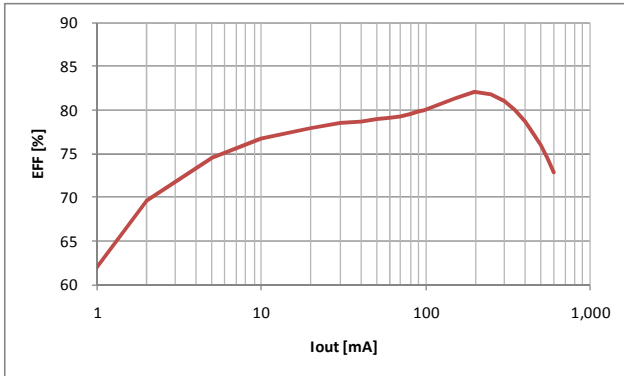

• Vin=3.6V, Vout=1.5V

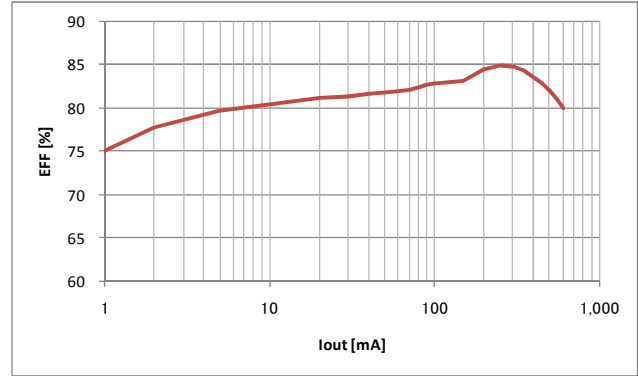

• Vin=3.6V, Vout=1.8V

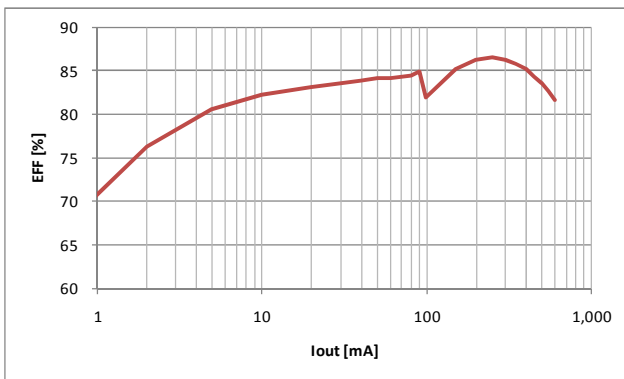

• Vin=3.6V, Vout=3.0V

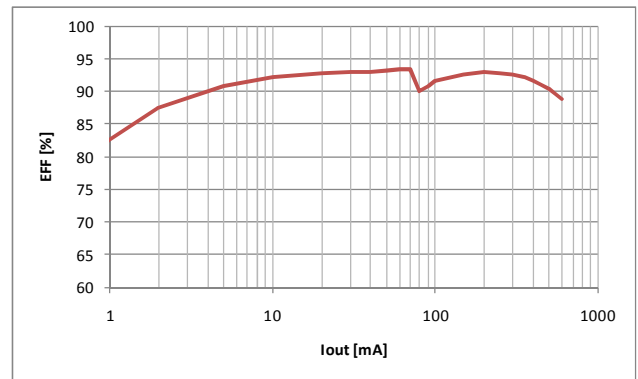

• Vin=5.0V, Vout=3.3V

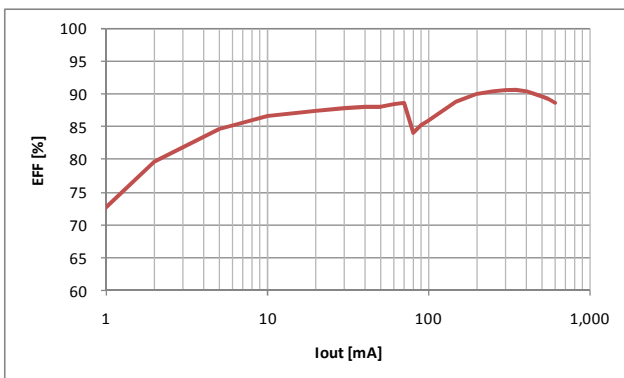

Typical Measurement Data (reference purpose only) (Ta=25°C)

Load Regulation

• Vin=3.6V, Vout=1.2V

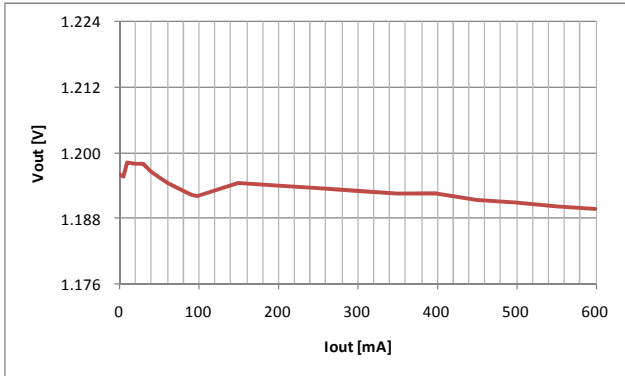

• Vin=3.6V, Vout=1.5V

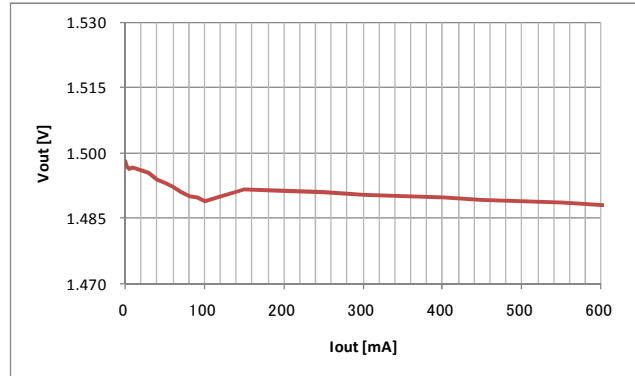

• Vin=3.6V, Vout=1.8V

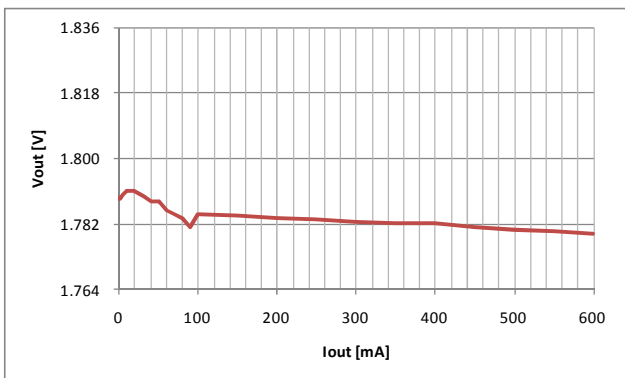

• Vin=3.6V, Vout=3.0V

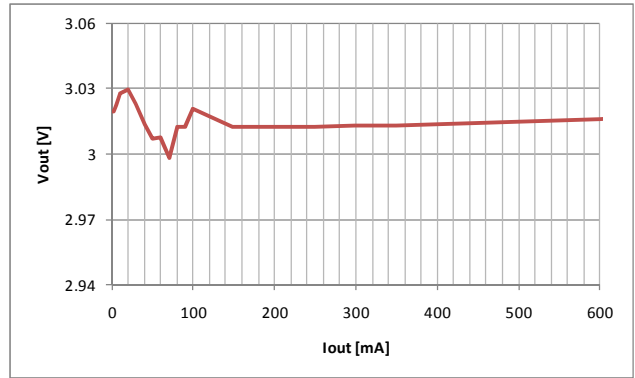

• Vin=5.0V, Vout=3.3V

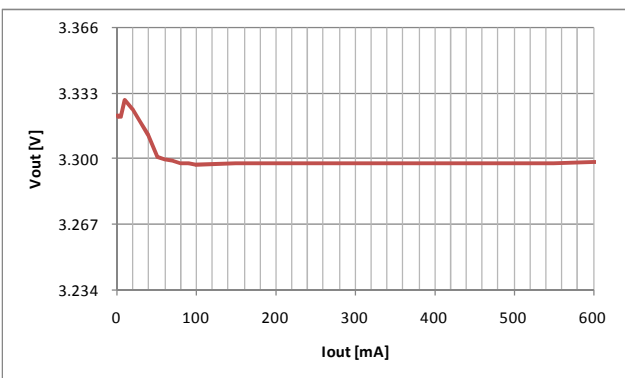

Typical Measurement Data (reference purpose only) (Ta=25°C)

Output Ripple-Noise

• Vin=3.6V, Vout=1.2V, BW : 150MHz

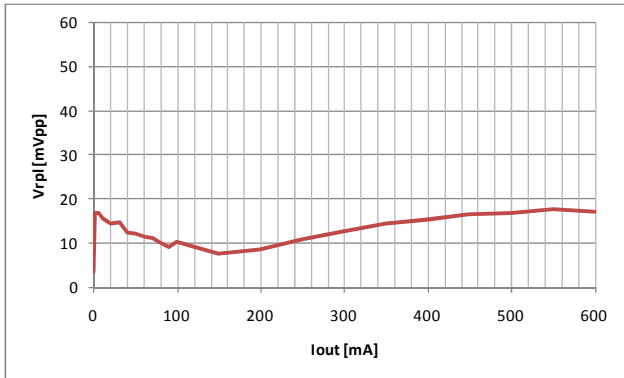

• Vin=3.6V, Vout=1.5V, BW : 150MHz

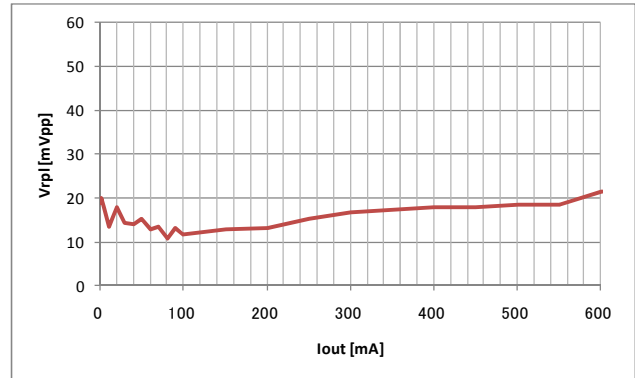

• Vin=3.6V, Vout=1.8V, BW : 150MHz

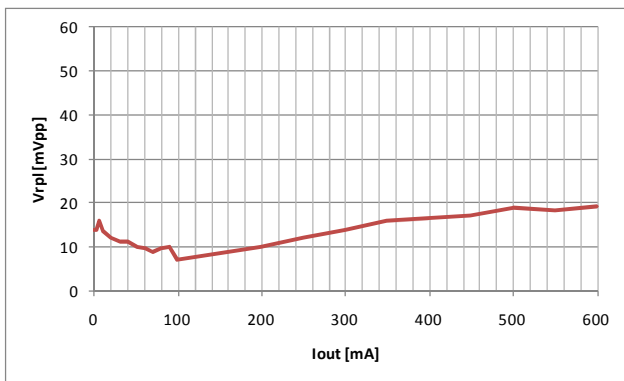

• Vin=3.6V, Vout=3.0V, BW : 150MHz

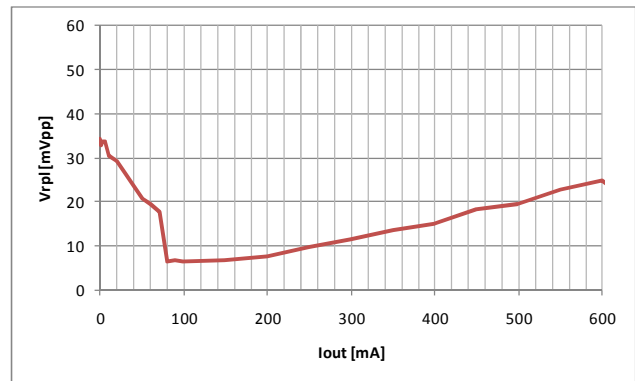

• Vin=5.0V, Vout=3.3V, BW : 150MHz

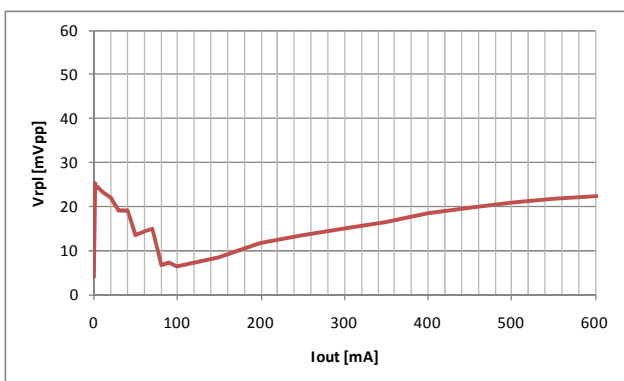

Typical Measurement Data (reference purpose only) (Ta=25°C)

Load Transient Response

• Vin=3.6V, Vout=1.2V, Mode : PFM/PWM

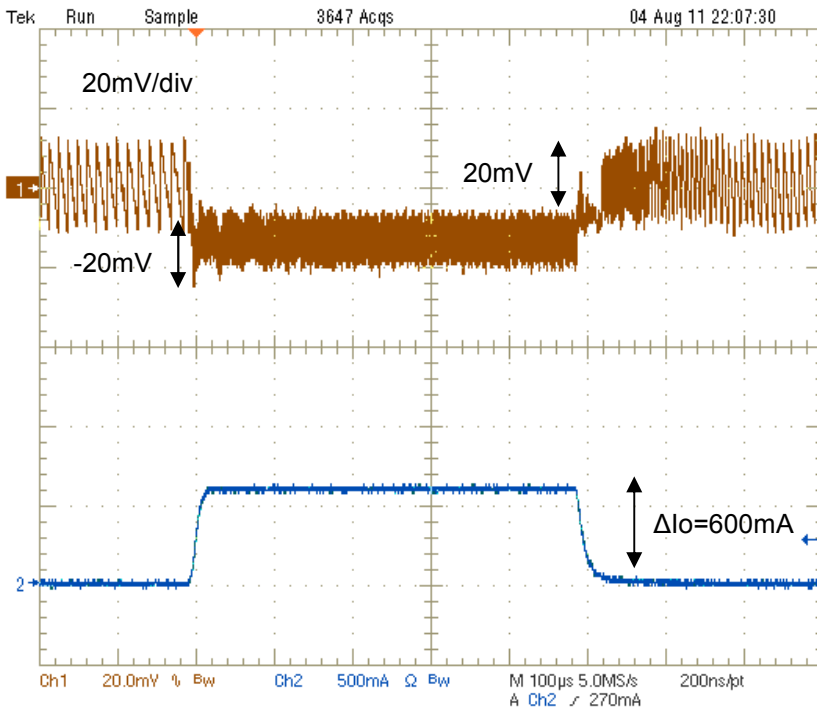

• Vin=3.6V, Vout=1.2V, Mode : PWM forced

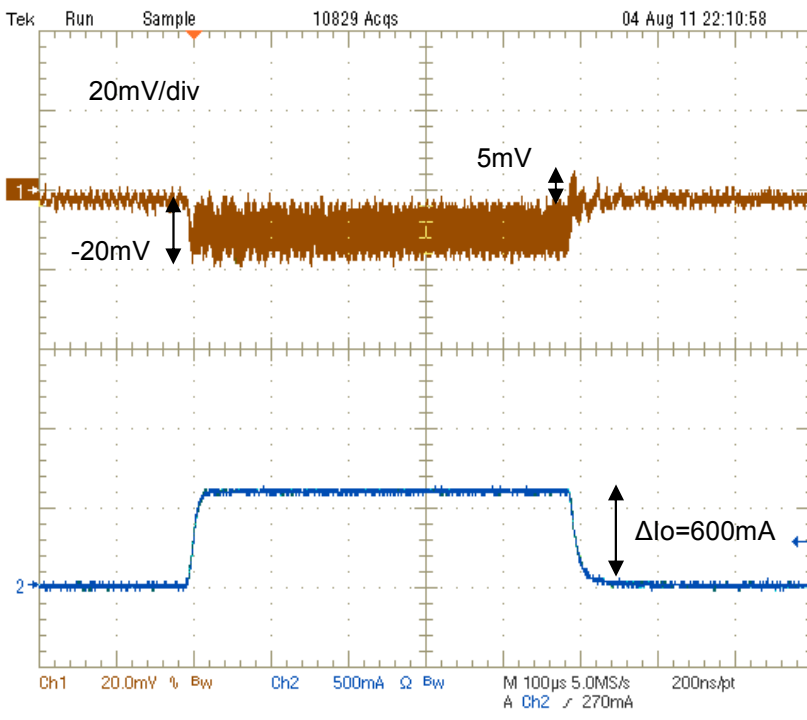

8. Tape and Reel Packing

1) Dimensions of Tape (Plastic tape)

Unit: mm

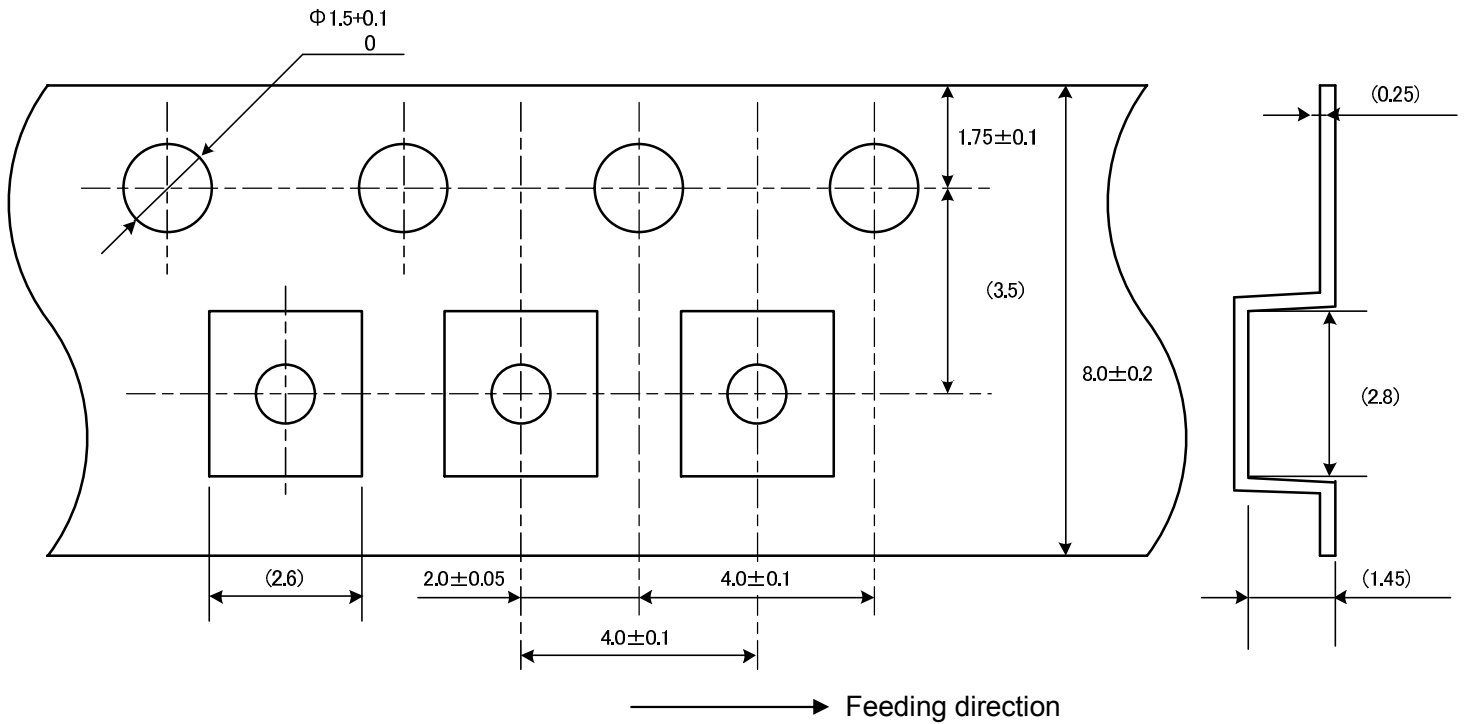

2) Dimensions of Reel

Unit: mm

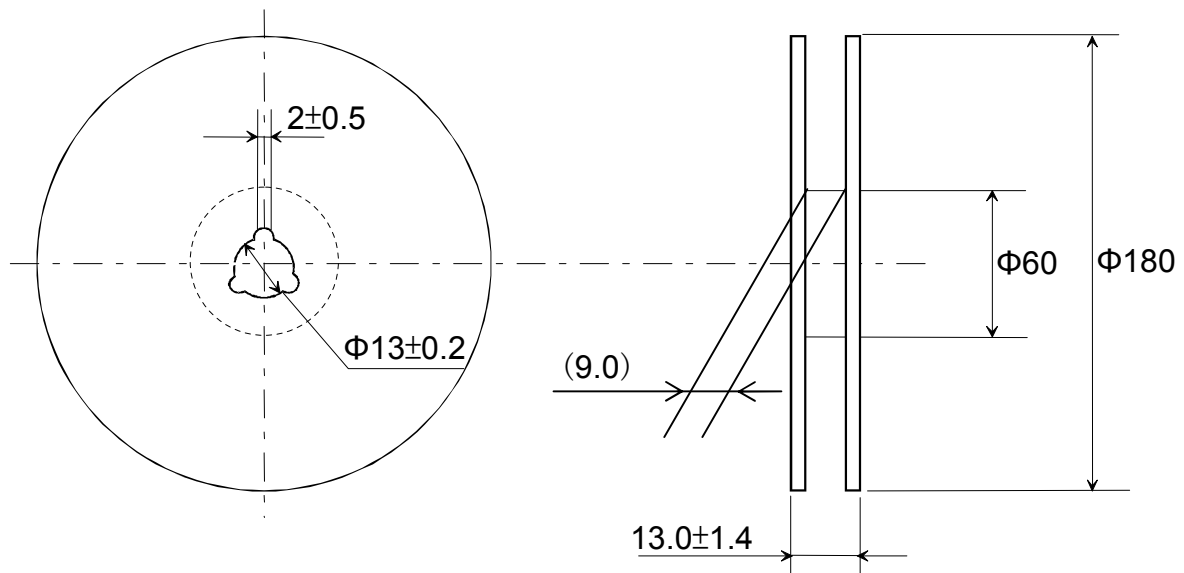

3) Taping Diagrams

- [1] Feeding Hole : As specified in (1)
- [2] Hole for chip : As specified in (1)
- [3] Cover tape : 50um in thickness
- [4] Base tape : As specified in (1)

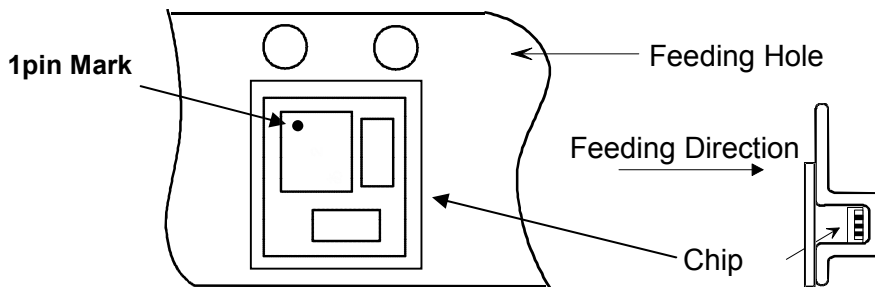
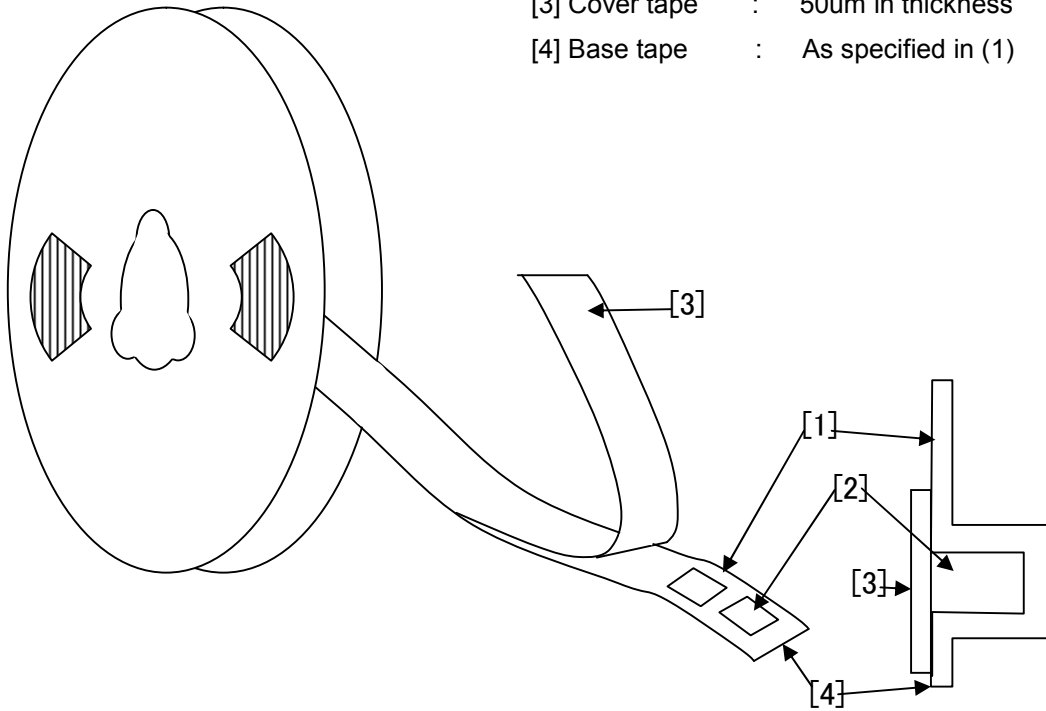

4) Leader and Tail tape

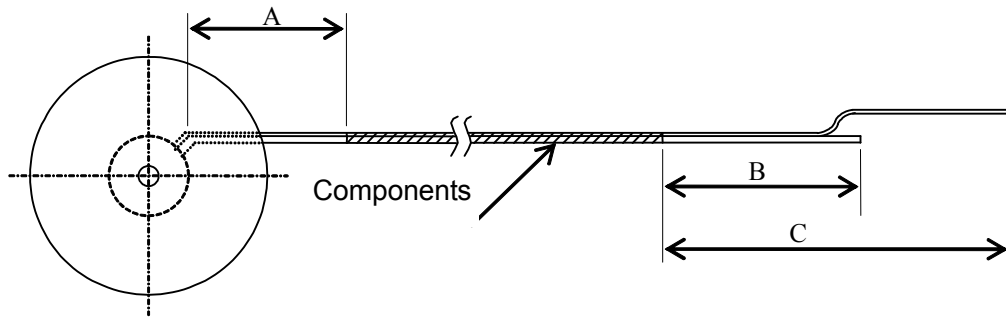

Symbol	Items	Ratings(mm)
A	No components at trailer	min 160
B	No components at leader	min 100
C	Whole leader	min 400

5) The tape for chips are wound clockwise, the feeding holes to the right side as the tape is pulled toward the user.

6) Packaging unit: 3,000 pcs./ reel

7) Material: Base Tape ... Plastic
 Reel ... Plastic
 Antistatic coating for both base tape and reel

8) Peeling of force

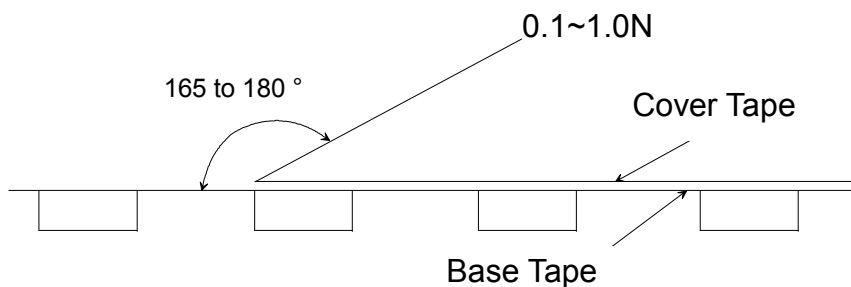

NOTICE

1. Storage Conditions:

To avoid damaging the solderability of the external electrodes, be sure to observe the following points.

- Store products where the ambient temperature is 15 to 35 °C and humidity 45 to 75% RH.
(Packing materials, In particular, may be deformed at the temperature over 40 °C.).
- Store products in non corrosive gas (Cl₂, NH₃, SO₂, NO_x, etc.).
- Stored products should be used within 6 months of receipt. Solderability should be verified if this period is exceeded

This product is applicable to MSL1 (Based on IPC/JEDEC J-STD-020).

2. Handling Conditions:

Be careful in handling or transporting the product. Excessive stress or mechanical shock may damage the product because of the nature of ceramics structure.

Do not touch the product, especially the terminals, with bare hands. Doing so may result in poor solderability.

3. Standard PCB Design (Land Pattern and Dimensions):

All the ground terminals should be connected to ground patterns. Furthermore, the ground pattern should be provided between IN and OUT terminals. Please refer to the specifications for the standard land dimensions.

The recommended land pattern and dimensions are shown for a reference purpose only. Electrical, mechanical and thermal characteristics of the product shall depend on the pattern design and material / thickness of the PCB. Therefore, be sure to check the product performance in the actual set. When using underfill materials, be sure to check the mechanical characteristics in the actual set.

4. Soldering Conditions:

Soldering is allowed up through 2 times.

Carefully perform preheating : ΔT less than 130 °C.

When products are immersed in solvent after mounting, pay special attention to maintain the temperature difference within 100 °C. Soldering must be carried out by the above mentioned conditions to prevent products from damage. Contact Murata before use if concerning other soldering conditions.

Reflow soldering standard conditions (example)

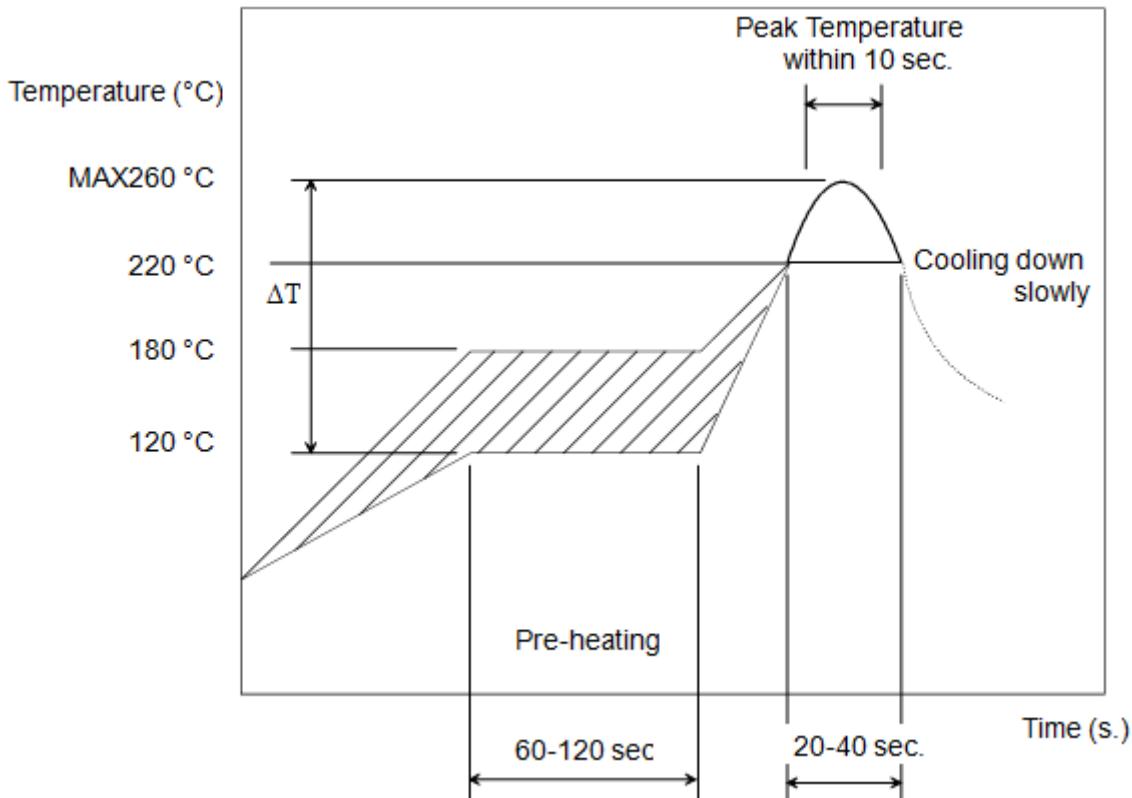

Use rosin type flux or weakly active flux with a chlorine content of 0.2 wt % or less.

5. Cleaning Conditions:

The product is not designed to be cleaned after soldering.

6. Operational Environment Conditions:

Products are designed to work for electronic products under normal environmental conditions (ambient temperature, humidity and pressure). Therefore, products have no problems to be used under the similar conditions to the above-mentioned. However, if products are used under the following circumstances, it may damage products and leakage of electricity and abnormal temperature may occur.

- In an atmosphere containing corrosive gas (Cl₂, NH₃, SO_x, NO_x etc.).
- In an atmosphere containing combustible and volatile gases.
- In a dusty environment.
- Direct sunlight
- Water splashing place.
- Humid place where water condenses.
- In a freezing environment.

If there are possibilities for products to be used under the preceding clause, consult with Murata before actual use.

If static electricity is added to this product, degradation and destruction may be produced.

Please use it after consideration enough so that neither static electricity nor excess voltage is added at the time of an assembly and measurement.

If product malfunctions may result in serious damage, including that to human life, sufficient fail-safe measures must be taken, including the following:

- (1) Installation of protection circuits or other protective device to improve system safety
- (2) Installation of redundant circuits in the case of single-circuit failure

7. Input Voltage and Output Current limitation:

Products shall be used in the input power capacity as specified in this specifications.

Inform Murata beforehand, in case that the components are used beyond such input power capacity range .

8. Limitation of Applications:

The products are designed and produced for application in ordinary electronic equipment (AV equipment, OA equipment, telecommunication, etc). If the products are to be used in devices requiring extremely high reliability following the application listed below, you should consult with the Murata staff in advance.

- Aircraft equipment.
- Aerospace equipment
- Undersea equipment.
- Power plant control equipment.
- Medical equipment.
- Transportation equipment (vehicles, trains, ships, etc.).
- Automobile equipment which includes the genuine brand of car manufacture, car factory-installed option and dealer-installed option.
- Traffic signal equipment.
- Disaster prevention / crime prevention equipment.
- Data-processing equipment.
- Application which malfunction or operational error may endanger human life and property of assets.
- Application which related to occurrence the serious damage
- Application of similar complexity and/ or reliability requirements to the applications listed in the above.



Note:

Please make sure that your product has been evaluated and confirmed against your specifications when our product is mounted to your product.

Product specifications are subject to change or our products in it may be discontinued without advance notice.

This catalog is for reference only and not an official product specification document, therefore, please review and approve our official product specification before ordering this product.