

# DC-DC Converter Application Manual

## MYGTM01210BZN

### 1. Features

- Single output/SIL/non-isolated type DC-DC converter with high power (120W).
- High efficiency and small size have been achieved.
- Wide input range (17.0V to 40.0V) .
- Wide adjustable output voltage range by connecting external resistance (5.0V to 12.0V).
- Shield case type.
- ON/OFF function and Short-circuit protection function are built in.

### 2. Appearance, Dimensions

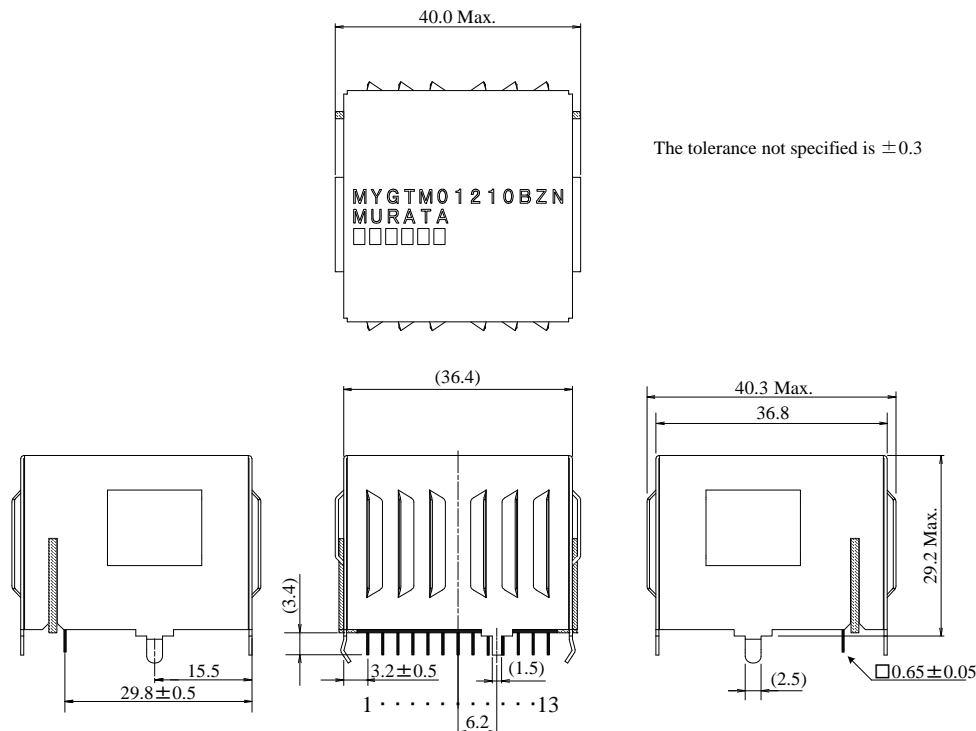

【Unit : mm】

( ) …reference value

Lead Pitch : 2.5 ±0.3mm

Distance between the both roots of Pin.

Tolerance is not accumulated.

### Marking

1. Manufacturer Parts Number **MYGTM01210BZN**

2. Manufacturer ID **MURATA**

3. Trace code □ □ □ □ □ □

① ② ③ ④ ④ ④

① Production Factory ID R : Kanazu Murata Mfg. Co.,Ltd.

② Production Year

③ Production Month (1,2,3, …,9,O,N,D)

④ Production Lot No. (3 end digit of Production Lot)

### ⚠ Note:

1. This datasheet is downloaded from the website of Murata Manufacturing co., ltd. Therefore, it's specifications are subject to change or our products in it may be discontinued without advance notice. Please check with our sales representatives or product engineers before ordering.
2. This datasheet has only typical specifications because there is no space for detailed specifications. Therefore, please approve our product specifications or transact the approval sheet for product specifications before ordering.

Pin Number and Function

Pin No.	Symbol	Function
1,2,3	Vin	Input
4	ON/OFF	Remote ON/OFF
5,6,7,8,9	GND	GND
10,11,12	Vout	Output
13	VAR	Output Voltage Adjust

## 3. Block Diagram

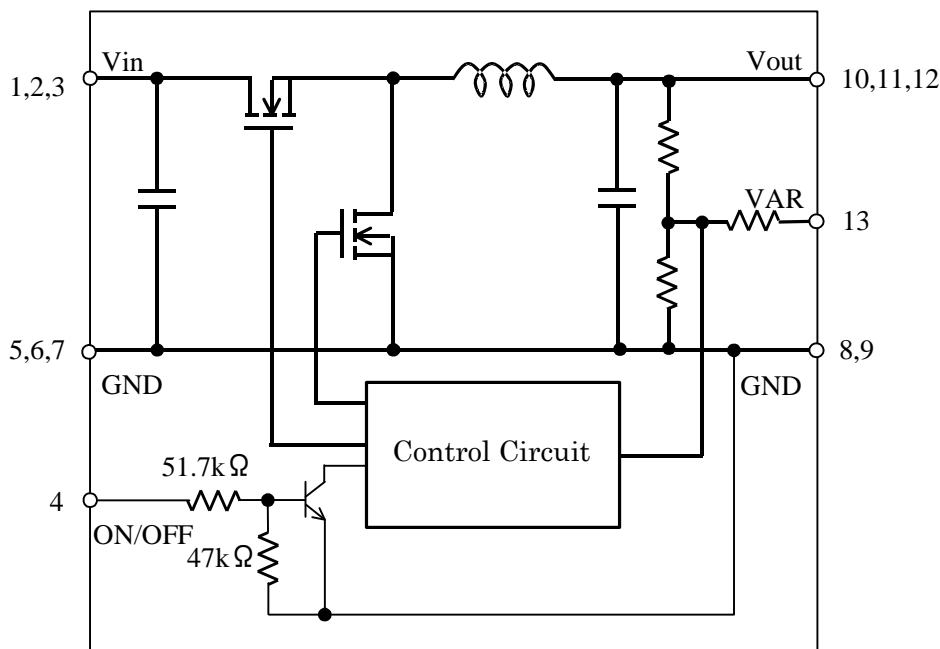

## 4. Absolute Maximum Rating

Input Voltage +45V

No voltage, no matter how instantaneous, shall be applied beyond the absolute maximum voltage rating to this product. If you apply any voltage over this limit the product characteristics will deteriorate or the product itself will be destroyed. Even though it may continue operating for a while after the over-voltage event, its life will likely be shortened significantly.

Reliability and life of the module may degrade similarly if the maximum operating voltage rating is continuously exceeded.

This product is designed to operate within the maximum operating voltage rating specification.

## 5. Environmental Conditions

- |     |                             |                                              |
|-----|-----------------------------|----------------------------------------------|
| 5.1 | Operating Temperature Range | -10°C ~ +80°C                                |
| 5.2 | Storage Temperature Range   | -20°C ~ +85°C                                |
| 5.3 | Operating Humidity Range    | 20% ~ 85% (No water condenses in any cases.) |
| 5.4 | Storage Humidity Range      | 10% ~ 90% (No water condenses in any cases.) |

## ⚠ Note:

1. This datasheet is downloaded from the website of Murata Manufacturing co., ltd. Therefore, it's specifications are subject to change or our products in it may be discontinued without advance notice. Please check with our sales representatives or product engineers before ordering.
2. This datasheet has only typical specifications because there is no space for detailed specifications. Therefore, please approve our product specifications or transact the approval sheet for product specifications before ordering.

## 6. Characteristics

## 6. 1 Electrical Characteristics (Ta=25 °C)

Item	Symbol	Condition	Value			Unit	
			Min.	Typ.	Max.		
Input Voltage Range	Vin		17.0	24.0	40.0	V	
Output Voltage	Vout	Vin=17.0~40.0V, Iout=0~10A	VAR=GND	11.64	12.00	12.36	V
			VAR=Open	4.85	5.00	5.15	
Output Current	Iout	Vin=17.0~40.0V, thermal derated	0	-	10.0	A	
Ripple Voltage	Vrpl	Vin=24V, Iout=10A, BW = 20MHz,	-	100	-	mV(pp)	
Efficiency	EFF	Vin =24V, Iout=10A, Vout=12V		97.3	-	%	
ON/OFF Voltage	VIH	Vin=17.0~40.0V	OFF	2.5	-	V	
	VIL		ON	-	-		0.5
Protection Output Current	Iocp	Vin=17.0~40.0V	10.5	-	-	A	
Short Circuit Protection	SCP	If output is shorted to GND, DC-DC Converter shall be operated in a hiccup mode. After the short circuit event has cleared, the output is automatically brought back into regulation.					

 Caution

The above electrical characteristics are guaranteed with the condition that the impedance of the input voltage source is sufficiently low as shown in section 6. Connecting an input inductance or using an input power supply with output inductance may cause an unstable operation of this device. Please check the proper operation of this device with the peripheral circuits on your system.

## 6. 2 Thermal Derating

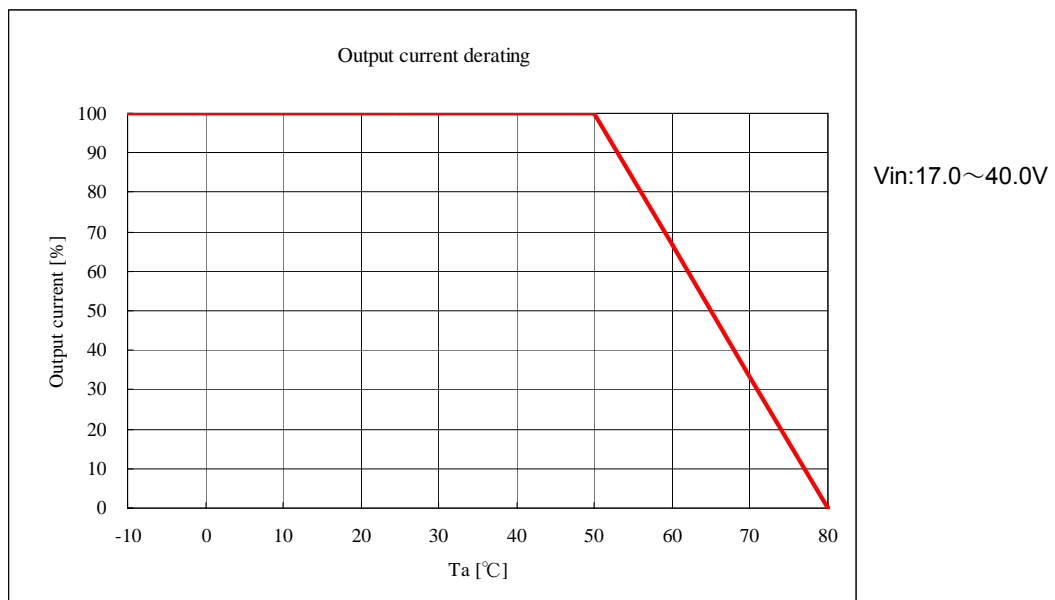

 Note:

1. This datasheet is downloaded from the website of Murata Manufacturing co., Ltd. Therefore, it's specifications are subject to change or our products in it may be discontinued without advance notice. Please check with our sales representatives or product engineers before ordering.
2. This datasheet has only typical specifications because there is no space for detailed specifications. Therefore, please approve our product specifications or transact the approval sheet for product specifications before ordering.

7. Pin Description

7.1. Adjusting the Output Voltage

The output voltage can be adjusted ranging from 5.0V to 12.0V by connecting resistors between VAR-pin(13pin) to GND-pin. The following equation gives the required external-resistor values to adjust the output voltage to Vo-adj. It is highly recommended that evaluation of the characteristics of this DC-DC converter's operation under your board conditions be thoroughly conducted.

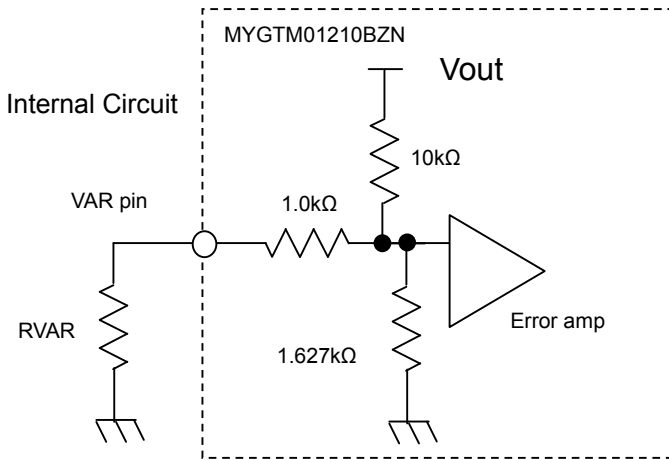

$$RVAR = \frac{10 \times 0.7}{Vo-adj - \left( \frac{10}{1.627} + 1 \right) \times 0.7} - 1.0 \text{ [k}\Omega\text{]}$$

<RVAR Calculation Example>

Vo-adj [V]	Calculated RVAR[kΩ]	RVAR Example
12.0	0	0Ω
9.0	0.751	750Ω
7.0	2.504	2.4kΩ + 100Ω
5.0	-2921	Open

7.2. ON/OFF Control

ON/OFF function

Using the ON/OFF feature, the operation of this product can be disabled without removal of the input voltage. Sequencing of a power supply system and power-saving control can be easily achieved using this function.

ON/OFF Control Operation

When ON/OFF-pin(4pin) is connected to Vin

..... Output Voltage =OFF

When ON/OFF-pin(4pin) is connected to GND or open

..... Output Voltage =ON

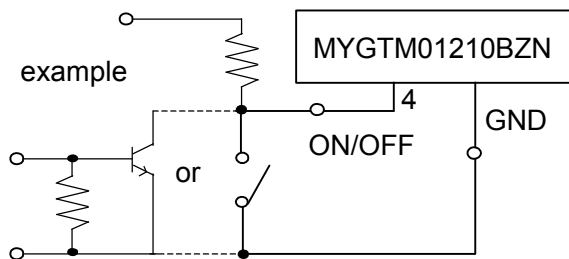

< Caution >

ON/OFF pin is pulled down inside of the DC-DC converter, so voltage appears up to GND at ON/OFF pin.

⚠ Note:

1. This datasheet is downloaded from the website of Murata Manufacturing co., ltd. Therefore, it's specifications are subject to change or our products in it may be discontinued without advance notice. Please check with our sales representatives or product engineers before ordering.
2. This datasheet has only typical specifications because there is no space for detailed specifications. Therefore, please approve our product specifications or transact the approval sheet for product specifications before ordering.

## 8. Test Circuit

## 8.1 Test Circuit

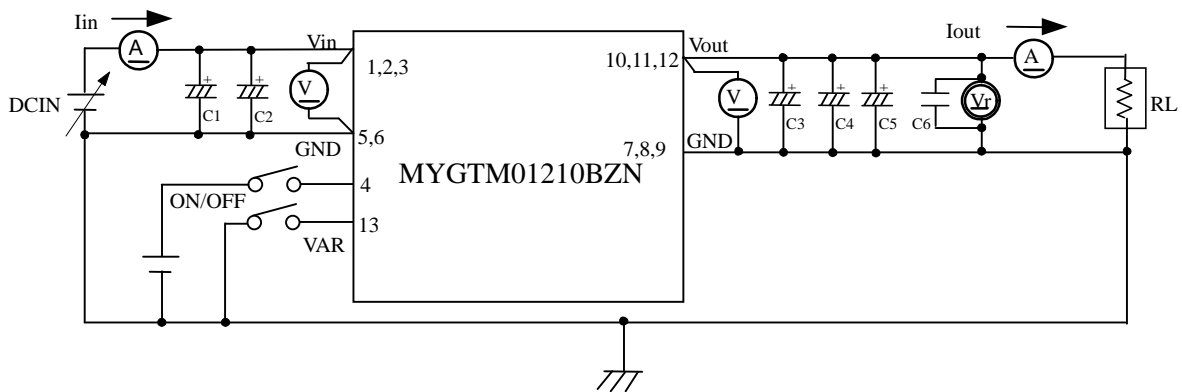

C1,C2 : 1000 $\mu$ F/50V Low Impedance Aluminum Electrolytic Capacitor(ZL series : Rubycon)  
 C3,C4,C5 : 1000 $\mu$ F/16V Low Impedance Aluminum Electrolytic Capacitor  
 (EKZE160ETD102MJ20S :NIPPON CHEMI-CON)  
 C6 : 0.1 $\mu$ F Ceramic Capacitor

Please make sure to place C1~C5 nearby input and output terminal of DC-DC converter.

## 8.2 Input/Output Aluminum Electrolytic Capacitor for full-wave rectifier (Reference)

\* When input is AC24V $\pm$ 10% 50Hz or 60Hz full-wave rectifier, please refer following external circuit.

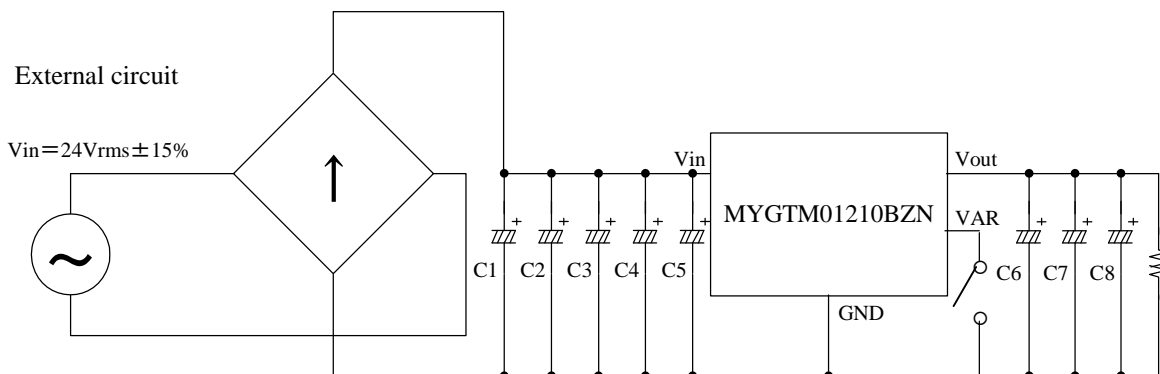

C1,C2,C3 : 1000 $\mu$ F/50V Low Impedance Aluminum Electrolytic Capacitor (EKZE500EC3102ML25S  
 NIPPON CHEMI-CON)

C6,C7,C8 : 1000 $\mu$ F/16V Low Impedance Aluminum Electrolytic Capacitor (EKZE160ETD102MJ20S

## ⚠ Note:

1. This datasheet is downloaded from the website of Murata Manufacturing co., Ltd. Therefore, it's specifications are subject to change or our products in it may be discontinued without advance notice. Please check with our sales representatives or product engineers before ordering.
2. This datasheet has only typical specifications because there is no space for detailed specifications. Therefore, please approve our product specifications or transact the approval sheet for product specifications before ordering.

## 9. Typical Characteristics Data

### 9.1 Static Electrical Characteristics

$V_{in}=17V, 24V, 40V$ ,  $V_{out}=5V$   
 ( $T_a=25^\circ C$ ,  $C_{in}=50ZL1000M*16\times 25 \times 2$ ,  $C_{out}=EKZE160ETD102MJ20S\times 3$ )

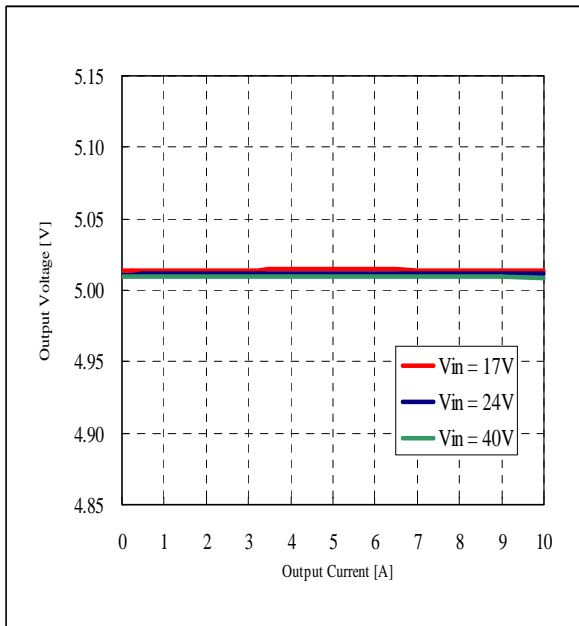

Fig.9-1-1. Output Voltage v.s. Output Current

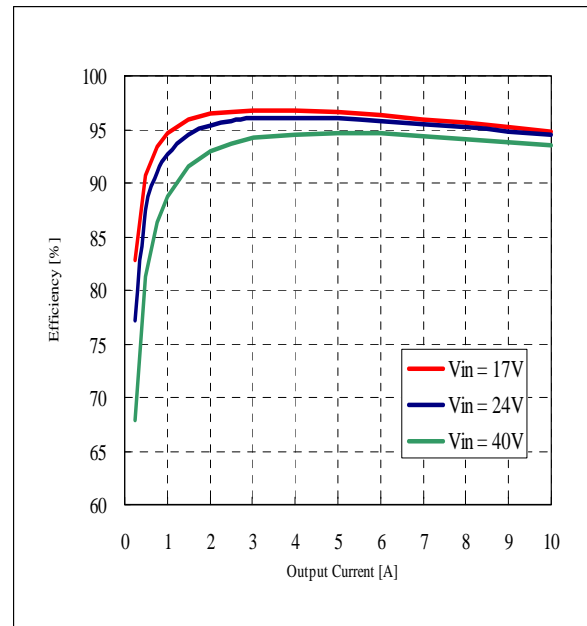

Fig.9-1-2. Efficiency v.s. Output Current

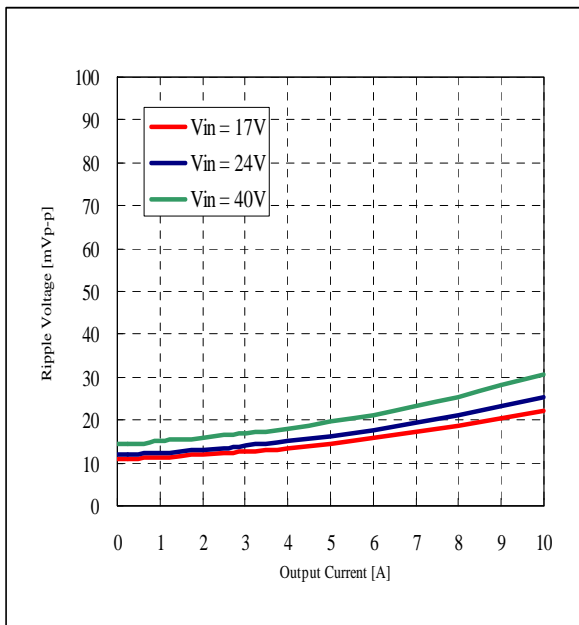

Fig.9-1-3. Ripple Voltage v.s. Output Current

#### ⚠ Note:

1. This datasheet is downloaded from the website of Murata Manufacturing co., Ltd. Therefore, it's specifications are subject to change or our products in it may be discontinued without advance notice. Please check with our sales representatives or product engineers before ordering.
2. This datasheet has only typical specifications because there is no space for detailed specifications. Therefore, please approve our product specifications or transact the approval sheet for product specifications before ordering.

$V_{in}=17V,24V,40V$ ,  $V_{out}=12V$   
 ( $T_a=25^\circ C$ ,  $C_{in}=50ZL1000M*16\times25 \times 2$ ,  $C_{out}=EKZE160ETD102MJ20S\times 3$ )

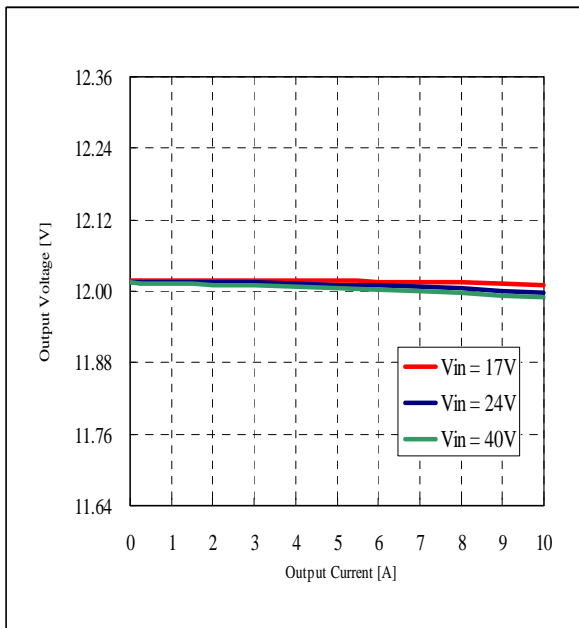

Fig.9-1-4. Output Voltage v.s. Output Current

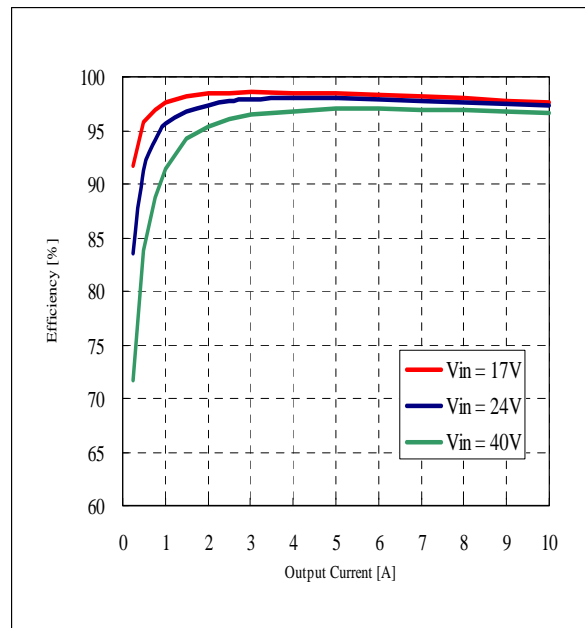

Fig.9-1-5. Efficiency v.s. Output Current

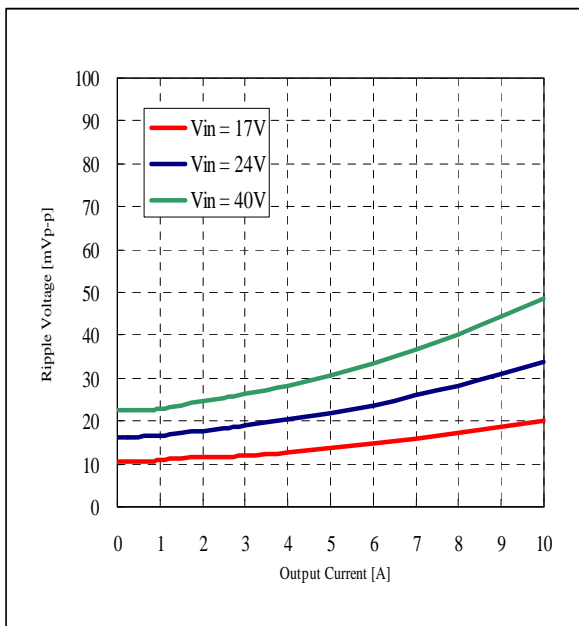

Fig.9-1-6. Ripple Voltage v.s. Output Current

**Note:**

1. This datasheet is downloaded from the website of Murata Manufacturing co., Ltd. Therefore, it's specifications are subject to change or our products in it may be discontinued without advance notice. Please check with our sales representatives or product engineers before ordering.
2. This datasheet has only typical specifications because there is no space for detailed specifications. Therefore, please approve our product specifications or transact the approval sheet for product specifications before ordering.

### 9. 2 Dynamic Electrical Characteristics

Vin=24V, Vout=5V  
 (Ta=25°C, Cin=50ZL1000M\*16\*25 ×2, Cout= EKZE160ETD102MJ20S×3)

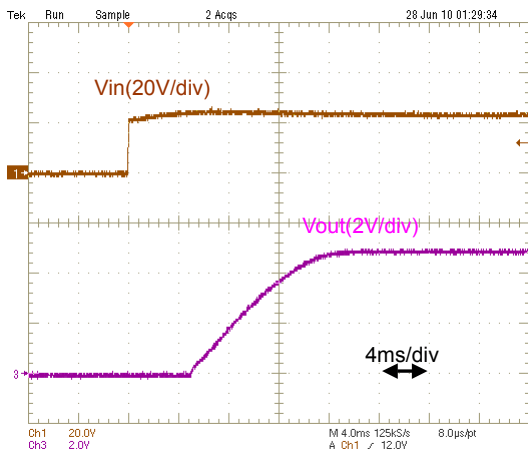

Fig.9-2-1. Start-up Waveform(Io=0A)

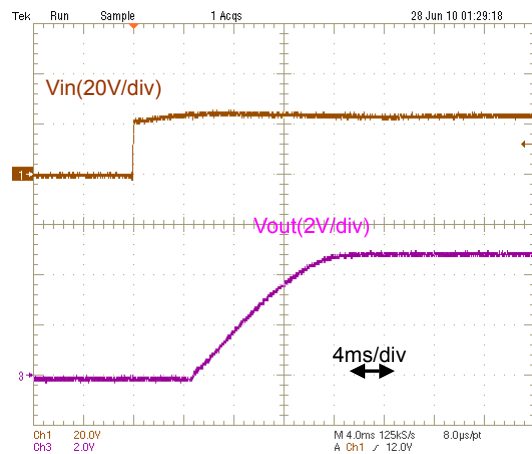

Fig.9-2-2. Start-up Waveform(Io=10A)

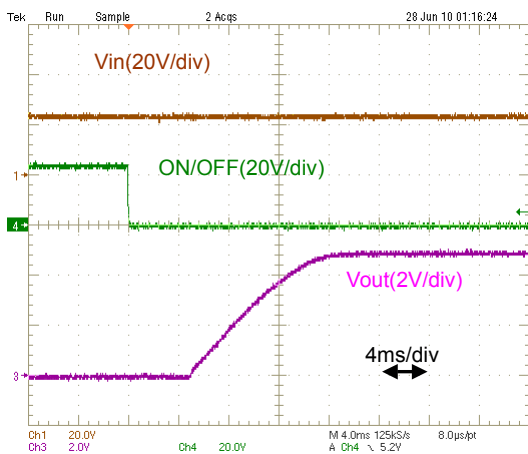

Fig.9-2-3. Start-up Waveform(Io=0A)

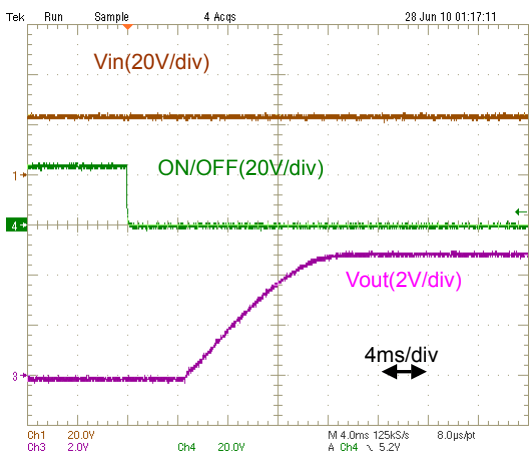

Fig.9-2-4. Start-up Waveform(Io=10A)

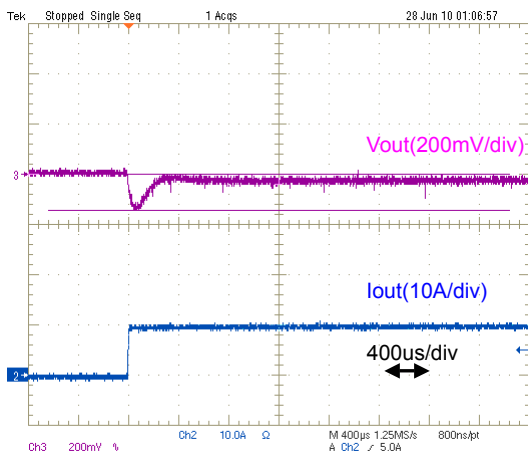

Fig.9-2-5. Load Transient Response (Io=0 → 10A)

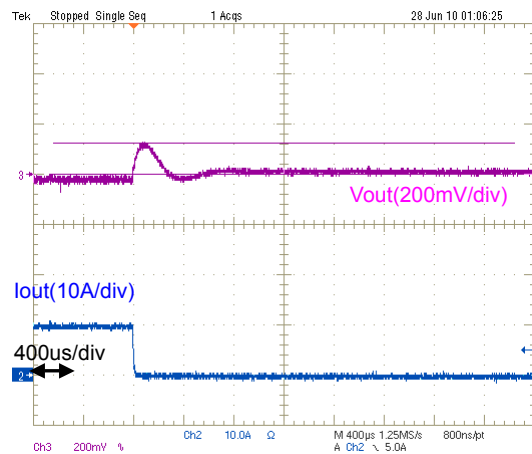

Fig.9-2-6. Load Transient Response (Io=10A → 0A)

**Note:**

1. This datasheet is downloaded from the website of Murata Manufacturing co., Ltd. Therefore, it's specifications are subject to change or our products in it may be discontinued without advance notice. Please check with our sales representatives or product engineers before ordering.
2. This datasheet has only typical specifications because there is no space for detailed specifications. Therefore, please approve our product specifications or transact the approval sheet for product specifications before ordering.



Vin=24V, Vout=12V  
 (Ta=25°C, Cin=50ZL1000M\*16×25 ×2, Cout= EKZE160ETD102MJ20S×3)

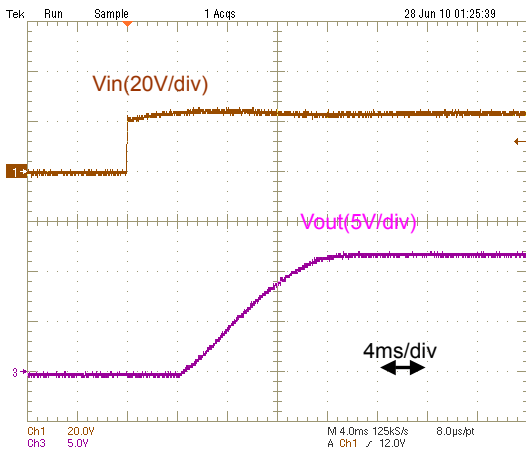

Fig.9-2-7. Start-up Waveform(Io=0A)

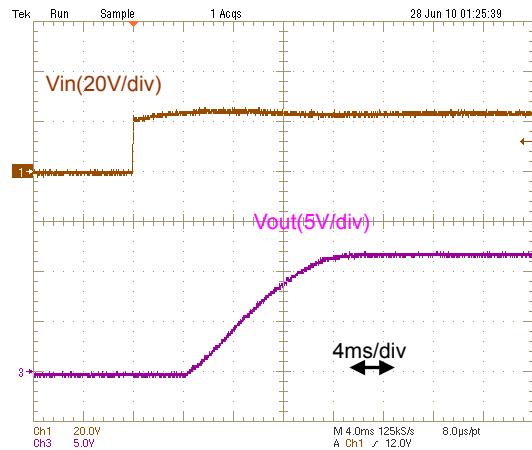

Fig.9-2-8. Start-up Waveform(Io=10A)

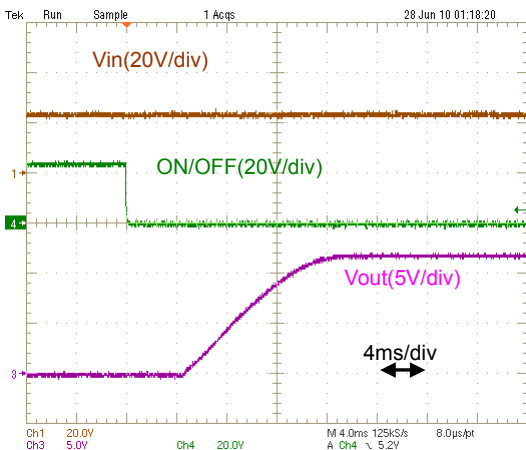

Fig.9-2-9. Start-up Waveform(Io=0A)

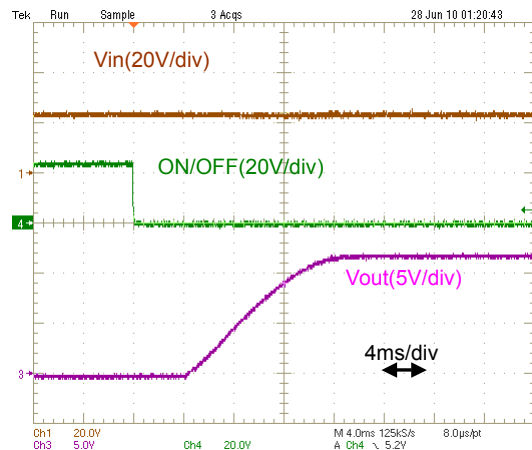

Fig.9-2-10. Start-up Waveform(Io=10A)

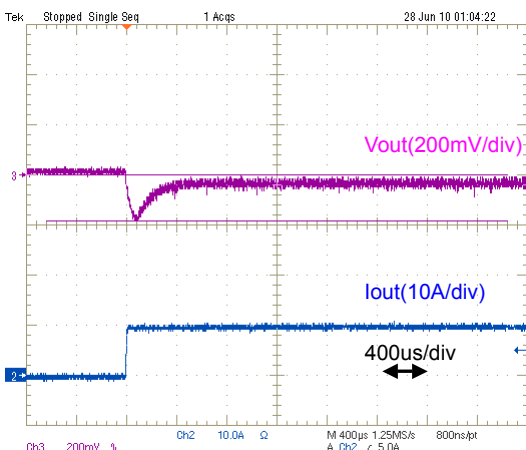

Fig.9-2-11. Load Transient Response (Io=0 → 10A)

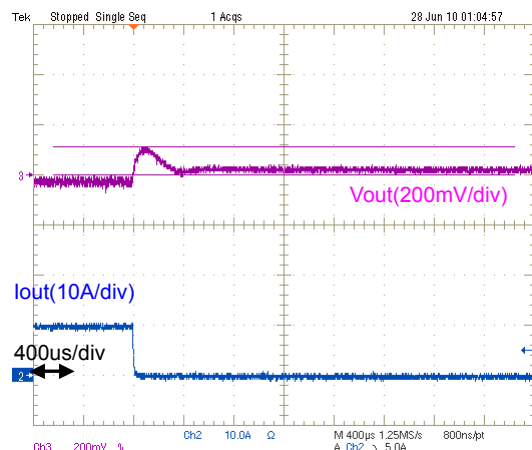
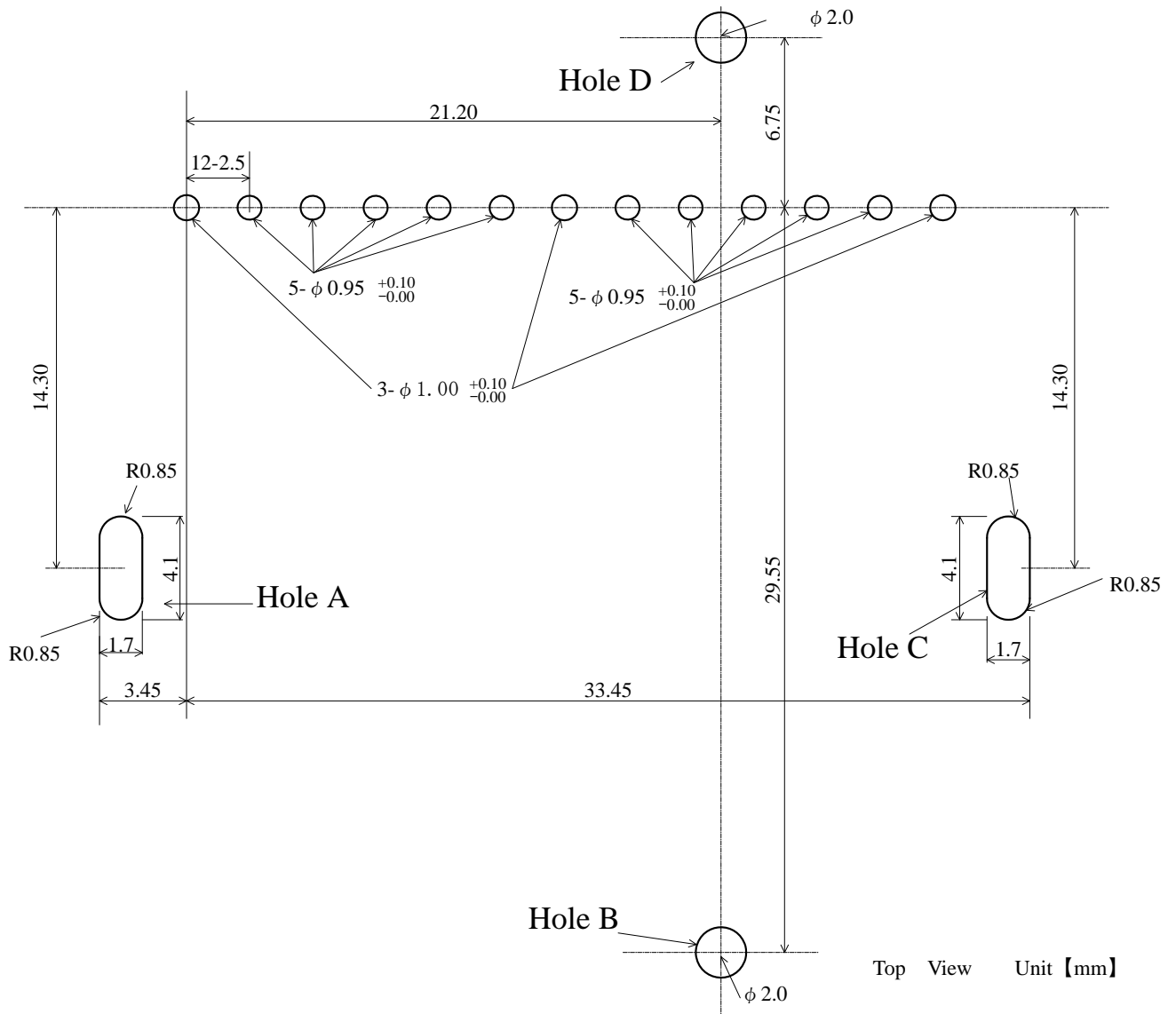

Fig.9-2-12. Load Transient Response (Io=10A → 0A)

**Note:**

1. This datasheet is downloaded from the website of Murata Manufacturing co., Ltd. Therefore, it's specifications are subject to change or our products in it may be discontinued without advance notice. Please check with our sales representatives or product engineers before ordering.
2. This datasheet has only typical specifications because there is no space for detailed specifications. Therefore, please approve our product specifications or transact the approval sheet for product specifications before ordering.

10. Pattern Layout  
10.1 Foot Print Dimensions



10.2 Patterning Area

Metal case is connected to GND. So hole A,B,C and D should be connected to GND.  
The Area indicated  is allowed no pattern or only GND pattern.

Hole A and C

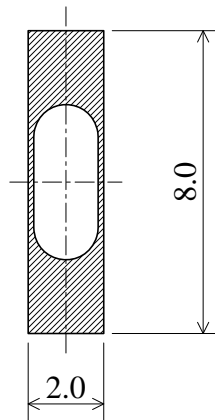

Hole B and D

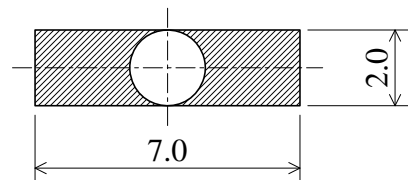

⚠ Note:

1. This datasheet is downloaded from the website of Murata Manufacturing co., ltd. Therefore, it's specifications are subject to change or our products in it may be discontinued without advance notice. Please check with our sales representatives or product engineers before ordering.
2. This datasheet has only typical specifications because there is no space for detailed specifications. Therefore, please approve our product specifications or transact the approval sheet for product specifications before ordering.

## 11. Notice

### 11.1 Soldering

#### 11.1.1 Flux

Please solder the products with no-cleaning type Rosin Flux which leaves little residue and low activity. Do not use cleaning type flux, in case that you wash the products after using cleaning type flux, they may damage mounting parts on the products and may cause defective or low quality products.

#### 11. 1.2 Solder

Please recommend use of the solder Sn-3Ag-0.5Cu.  
When use other solders, use it after examining at customer.

#### 11. 1.3 Condition of soldering

Please solder under the following condition.

- Flow soldering Preheating : 120±10 °C 60~120 seconds
- Soldering : 255±5 °C
- Time within : 10 seconds
- Condition of iron soldering : under 380 °C, 4 seconds at maximum  
(Only iron less than 30W should be used.)

### 11. 2 Cleaning

Please do not wash the products.

#### ⚠ Note:

1. This datasheet is downloaded from the website of Murata Manufacturing co., ltd. Therefore, it's specifications are subject to change or our products in it may be discontinued without advance notice. Please check with our sales representatives or product engineers before ordering.
2. This datasheet has only typical specifications because there is no space for detailed specifications. Therefore, please approve our product specifications or transact the approval sheet for product specifications before ordering.

## 12. Packaging Specification

### 12.1. Packing Form

These are packed in a tray(See Fig.12-1)

### 12.2. The number of products in pack specification form.

35pcs./tray

If the products have fraction, may not follow this specification.

### 12.3.Packaging Form

#### 12.3.1. Case of reuseable box is used.

These trayies packed products are packaging for Fig.12-2.

#### 12.3.2. Case of reuseable box is not used

These trayies packed products are packaging for Fig.12-3.

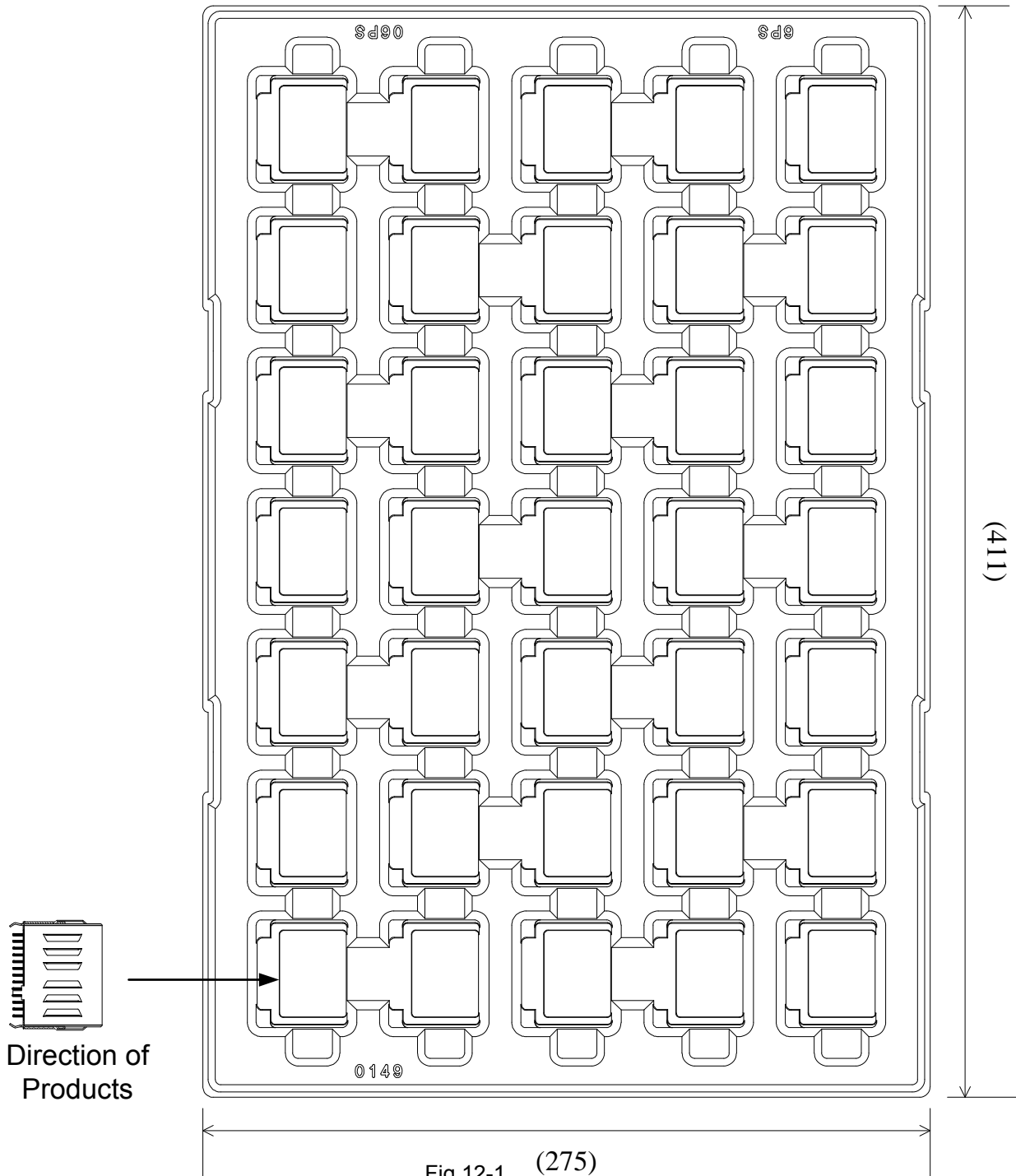

#### ⚠ Note:

1. This datasheet is downloaded from the website of Murata Manufacturing co., ltd. Therefore, it's specifications are subject to change or our products in it may be discontinued without advance notice. Please check with our sales representatives or product engineers before ordering.
2. This datasheet has only typical specifications because there is no space for detailed specifications. Therefore, please approve our product specifications or transact the approval sheet for product specifications before ordering.

As in Figure 2, six trays are packed up in the outside packing box .(Number of packed traies is 5 and Empty traies is 1)  
 When there is a fraction, packing up the empty tray. (Number of all traies is allways 6.)  
 Then, traies piles up alternately.

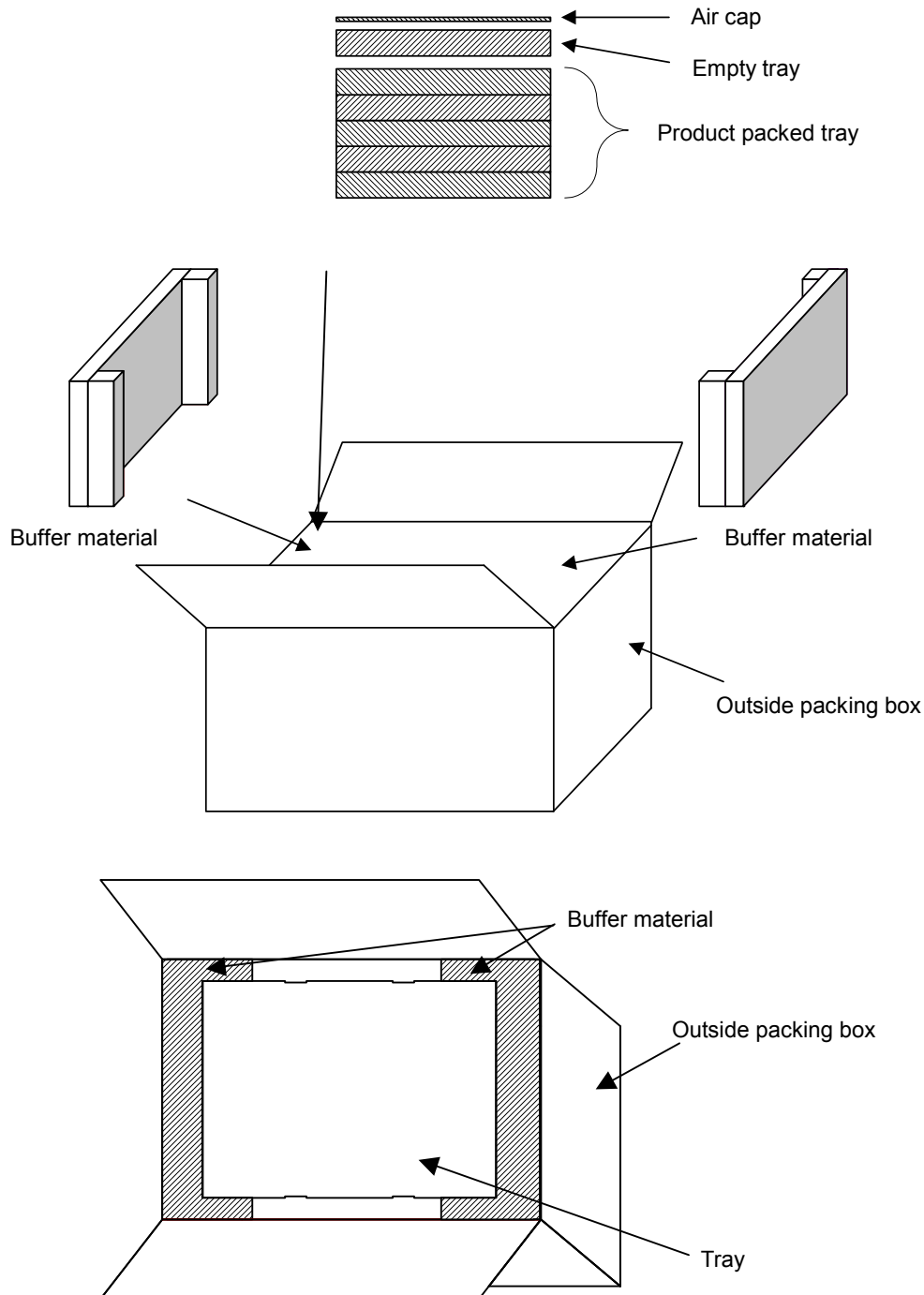

Fig.12-2

⚠ **Note:**

1. This datasheet is downloaded from the website of Murata Manufacturing co., ltd. Therefore, it's specifications are subject to change or our products in it may be discontinued without advance notice. Please check with our sales representatives or product engineers before ordering.
2. This datasheet has only typical specifications because there is no space for detailed specifications. Therefore, please approve our product specifications or transact the approval sheet for product specifications before ordering.

As in Figure 2, six trays fixed by banding band are packed up in the corrugated fiberboard box. (Number of packed trays is 5 and Empty trays is 1.)  
 When there is a fraction, fixed the empty trays by banding band. (Number of all trays is always 6.)  
 Then, trays piles up alternately.

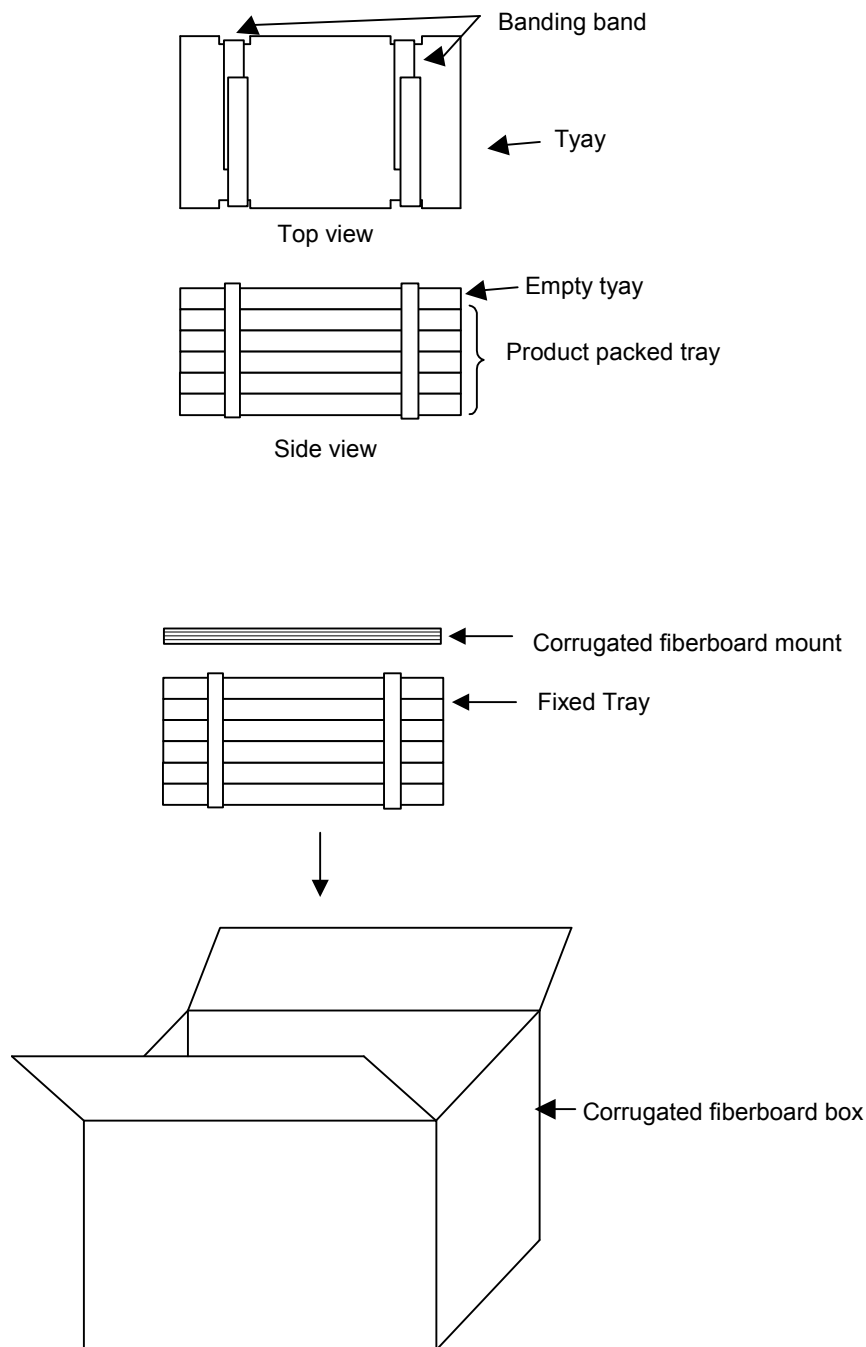
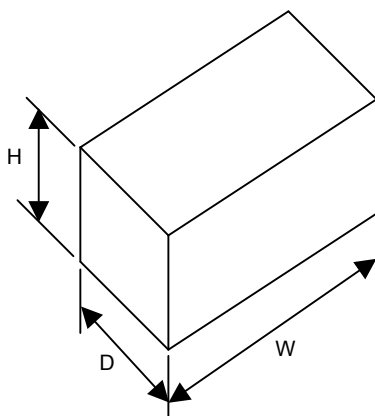

Fig.12-3

⚠ **Note:**

1. This datasheet is downloaded from the website of Murata Manufacturing co., ltd. Therefore, it's specifications are subject to change or our products in it may be discontinued without advance notice. Please check with our sales representatives or product engineers before ordering.
2. This datasheet has only typical specifications because there is no space for detailed specifications. Therefore, please approve our product specifications or transact the approval sheet for product specifications before ordering.

Item	Specification
Packaging form typical classification	Box
Dimensions of packaging form (typ.)	<p>Case of reuseable box is used.</p> <p>W = 538 ( mm ) D = 368 ( mm ) H = 284 ( mm )</p> <p>Case of reuseable box is not used</p> <p>W = 432 ( mm ) D = 296 ( mm ) H = 264 ( mm )</p>
The number of products in packaging form	175( p c s )
Mass of one product	45( g ) Typ.
<p>Remark</p> <p>If the products have fraction, may not follow this specification.</p> <p>※On the Packing case, the following is indicated.</p> <p>Murata Parts No.</p> <p>Quantity</p> <p>Stamp No.</p>	



⚠ **Note:**

1. This datasheet is downloaded from the website of Murata Manufacturing co., ltd. Therefore, it's specifications are subject to change or our products in it may be discontinued without advance notice. Please check with our sales representatives or product engineers before ordering.
2. This datasheet has only typical specifications because there is no space for detailed specifications. Therefore, please approve our product specifications or transact the approval sheet for product specifications before ordering.

## 13. Notice

## 13.1. Input / Output capacitor

When an inductance or a switch device are connected to the input line, or when you use a power supply with output inductance as the input voltage source, the input voltage of the DC-DC converter will be fluctuated. By this input voltage fluctuation, the transient load response of the DC-DC converter may be deteriorated or abnormal oscillation may occur. So please confirm normal operation on each application.

Please use external input capacitor in order to decrease inductance of input line.

In case you use external output capacitor in order to improve transient load response, please use input capacitor to prevent abnormal oscillation. When you use external capacitors, following capacitors are recommendable.

Output capacitor (C3+C4+C5+C6) : Please use capacitors less than 4500 $\mu$ F

## 13.2. Wiring of input / output capacitor

In the case of input / output capacitor connection, in order to reduce electrical noise, please design PCBs with consideration of the following item.

- ①. Please be sure to check normal operation on your system.
- ②. Please use low impedance capacitors with good high frequency characteristic.
- ③. Please shorten those leads of each capacitor as much as possible, and make sure the lead inductance is low.
- ④. Both input-side and output side, please make the wiring loop between plus and minus as small as possible. The influence of leakage inductance can be reduced.
- ⑤. Please design the print pattern of the main circuit as wide and short as possible.

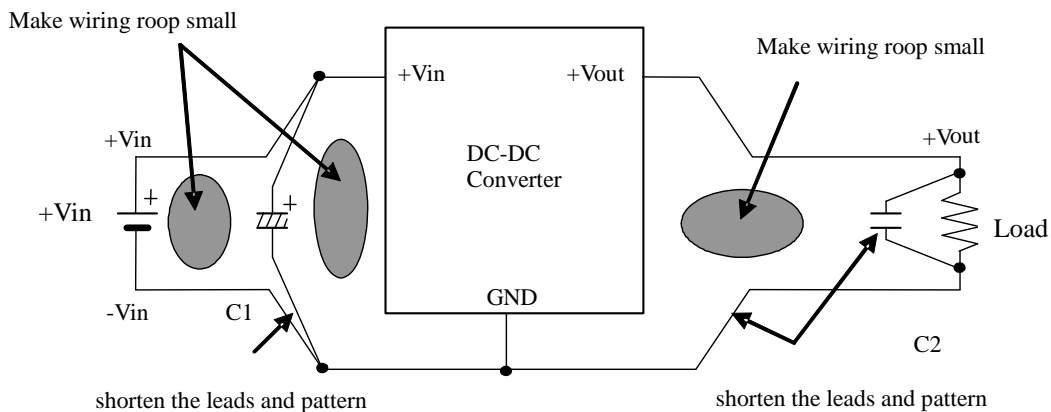

13.3. This product should not be operated in parallel or in series.

13.4. Please do not use a connector or a socket to connect this product to your product. The electric characteristics may be deteriorated by the influence of contact resistance.

13.5. Be sure to provide an appropriate fail-safe function on your product to prevent secondary damage that may be caused due to abnormal functional or failure of this product.

13.6. Inrush current protection is not a feature of this product.

13.7. Please connect the input terminals with the correct polarity. If an error in polarity connection is made this product may be damaged. If this product is damaged internally, an elevated input current may flow, and so this product may exhibit an abnormal temperature rise, or your product may be damaged. Please add a diode and fuse per the following diagram to protect them.

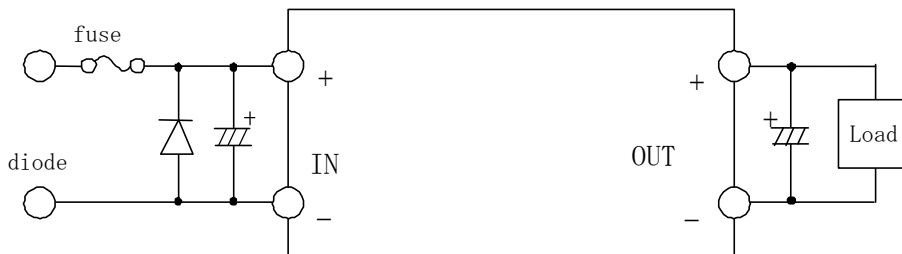

Standard of fuse : current rating 15A

※Please select diode and fuse after confirming the operation of your product.

## △ Note:

1. This datasheet is downloaded from the website of Murata Manufacturing Co., Ltd. Therefore, its specifications are subject to change or our products in it may be discontinued without advance notice. Please check with our sales representatives or product engineers before ordering.
2. This datasheet has only typical specifications because there is no space for detailed specifications. Therefore, please approve our product specifications or transact the approval sheet for product specifications before ordering.



 **Note**

1. Please contact our main sales office or nearby sales office before using our products for the applications listed below which require especially high reliability for the prevention of defects which might directly cause damage to the third party's life, body or property or this products for any other applications that described in the above.
  - ① Aircraft equipment
  - ② Aerospace equipment
  - ③ Undersea equipment
  - ④ Power plant control equipment
  - ⑤ Medical equipment
  - ⑥ Transportation equipment (vehicles, trains, ships, etc.)
  - ⑦ Traffic signal equipment
  - ⑧ Disaster prevention /crime prevention equipment
  - ⑨ Data-processing equipment
  - ⑩ Application of similar complexity and/or reliability requirements to the applications listed in the above.
2. This catalog is indicated in July 2010. About the written contents, since changing without a preliminary announcement for improvement and supply are sometimes stopped, please confirm in case of ordering. If written contents are unknown, please ask to our main sales office or nearby sales office.
3. Types and specification in this catalog are referenced for your information only. Please confirm detailed specifications by approving our individual drawing and specification sheet.

 **Note:**

1. This datasheet is downloaded from the website of Murata Manufacturing co., ltd. Therefore, it's specifications are subject to change or our products in it may be discontinued without advance notice. Please check with our sales representatives or product engineers before ordering.
2. This datasheet has only typical specifications because there is no space for detailed specifications. Therefore, please approve our product specifications or transact the approval sheet for product specifications before ordering.